



TERRAIN SDP

POLYBUTYLENE TECHNICAL MANUAL
A professional system for plumbing and heating installations



Nº LINDAD Nº PLANO MATERIAL
NUEVA TERRAIN
FIRMA REA EC



CONTENTS

4	FOREWORD
5	1. PLASTIC MATERIALS
6	1.1. Where do plastics come from?
6	1.2. What are plastics like "inside"?
6	1.3. Classification of plastic materials
7	1.4. Thermoplastics
8	1.5. Thermoset plastics
8	1.6. Elastomers
9	1.7. Terrain polybutylene (PB)
9	1.8. Essential characteristics of plastic materials
12	2. THE HISTORY OF POLYBUTYLENE-1 (PB-1)
13	2.1. The raw material: Polybutylene-1 (PB)
14	2.2. PB-1 in the indoor distribution of drinking water
15	2.3. The Terrain PB-1 system in the indoor distribution of drinking water
16	3. POLYBUTYLENE CHARACTERISTICS AND PB PIPING SYSTEM
17	3.1. Polybutylene characteristics
17	3.2. Comparison of physical characteristics between materials
19	3.3. Noise transmission
19	3.4. Water hammer
20	3.5. Oxygen permeability
21	3.6. Legionella
22	3.7. Fire
22	3.8. Pipe bending
23	3.9. Oxidising agents
24	3.10. Cryogenic behaviour
	3.11 Embedded pipes
25	4. PRESSURE AND TEMPERATURE RESISTANCE OF THE PIPING SYSTEM
26	4.1. Calculation procedure for the working pressure of a pipe
26	4.2. Calculation for the design pressure of a pipe
27	4.3. Regression curve
28	4.4. Safety factor
28	4.5. Calculation example
29	4.6. Pipe series
31	4.7. Standard pressures obtained from this process
31	4.8. Dimensional equivalences
32	5. INTERNATIONAL STANDARDS FOR PIPING SYSTEMS
33	5.1. International standards for PB systems: UNE-EN ISO 15876
33	5.2. Field of application of PB systems
33	5.3. Classification of working conditions for PB systems
34	5.4. Calculation method for pipe dimensioning
39	5.5. Pipe marking
41	6. PB-1 SYSTEMS AND SUSTAINABLE CONSTRUCTION
42	6.1. Comparative environmental impact study
44	6.2. Standardisation and legislation. Future trends
45	7. JOINT SYSTEMS
47	7.1. Push-fit joint
50	7.2. Socket fusion joint
53	7.3. Electrofusion joint
56	7.4. Butt fusion joint
60	7.5. Flanged joint
62	7.6. Transition joints
64	7.7. Leak testing in the installations

68	8. FLOW RATE AND HEAD LOSS
69	8.1. Installation dimensioning
70	8.2. Head loss in pipes
70	8.3. Localised head loss
71	8.4. Temperature correction factor
72	8.5. Head loss for handling other fluids
72	8.6. Calculation example
73	9. EXPANSION, COMPENSATION AND CLAMPS
74	9.1. Expansion and compensation
74	9.1.1. Expansion and stress in different materials
76	9.2. Installation techniques
76	9.2.1. Installation of variable length pipes
76	9.2.1.1. Placement of the anchor points
78	9.2.1.2. Compensation of the variation in length using an expansion offset
80	9.2.1.3. Compensation of the variation of the length with a loop
82	9.2.1.4. Examples of expansion absorption using expansion offsets and loops
84	9.2.1.5. Installation of clamps for installations that allow variations in piping length.
85	9.2.1.6. Compensation of the length variation with continuous horizontal supports
86	9.2.1.7. Installation of assembly columns with “natural loops”
87	9.2.2. Installation of non-variable length pipes
88	9.2.2.1 Recommendations for fixed-assembly installations
88	9.2.2.2 Distances between clamps for fixed assembly
88	9.2.2.3 Selection of the threaded rod for securing clamps
90	9.2.2.4 Examples of fixed-assembly installations
91	9.3. Selection of the installation procedure
92	10. INSTALLATIONS
93	10.1. Line or traditional installations
93	10.2. Installation of distribution using manifolds (spider type)
94	10.3. Accessible installations (pipe-in-pipe)
96	10.4. Installations in plasterboard drywalls
97	10.5. Large diameters
98	11. THERMAL INSULATION FOR PIPES
101	12. Chilled water application
101	12.1. Chilled water
106	13. QUALITY CONTROL
107	13.1. AENOR Certification for PB pipes
108	13.2. AENOR Certification for PB fittings
109	13.3. AENOR Certification for the complete PB system
111	13.4. Kiwa certification
111	13.5. Nueva Terrain laboratory and workshop
112	13.6. List of applicable standards and legislation
113	ANNEXES:
114	Annex 1: Polybutylene regression curve
115	Annex 2: Regression curves of various materials at 80°C
116	Annex 3: Miner's rule
116	Annex 4: Calculation of stress design for class 2 in PB pipes
118	Annex 5: Head loss in PB pipes according to international standard ISO/TR 10501
123	Annex 6: Graph for the calculation of expansion in PB pipes
124	Annex 7: Graph for determining the expansion force in PB pipes
125	Annex 8: Table of PB resistance to chemical agents
131	Annex 9: Sum-Up of TENDER specification according TERRAIN SDP
133	Annex 10: Hot water expulsion time

Foreword

The purpose of this technical manual is to provide an objective and scientific justification of the technical characteristics of the SDP Terrain Polybutylene piping systems for hot and cold water supply, as well as their use in these installations. The wide range of the content and the depth we could go into could lead us to publish an encyclopaedia on the subject.

But this is not our aim; what we are hoping to do is offer a clear explanation of our piping systems and show the reader their differences and advantages compared to other systems and materials. The different qualities and advantages of plastic compared to metal systems are widely known and accepted. However, this is not the case between the newer products within this market. It is common to find a wide range of piping systems on the market that fall under the same umbrella term or definition of plastic piping, but, as we will see below, their characteristics and features are completely different.

The main goal, therefore, is to fully and concisely describe both the material and the system, although frequently these two concepts are not compatible. The aim of this manual is not to go into depth in the theory of the mechanical and hydraulic aspects, as this can be found in the technical literature and some cases it is not specifically related to piping materials. In addition, the results of this technical investigation have also been summarised and transposed into the applicable legislation and standards as recommendations or installation requirements. The regulatory scope will also be quoted, although only in general and depending on the corresponding application.

Polybutylene, as we will verify below, is the thermoplastic with the best physical and mechanical characteristics of those used for water piping in the home. These characteristics, in conjunction with the variety and reliability of the joint techniques of our system, make it the optimal choice for all installations and situations. To complement this manual, Nueva Terrain has additional information in the form of Technical Product Sheets or Technical Notes that go into further detail in various topics regarding installations, legislation and instructions for assembly.

Finally we would like to remind you that beyond the written description of the system, which reflects the product knowledge and catalogue at the time of writing, our Technical and sales Departments are available to respond to any of your doubts regarding the installations and materials whenever you need them. Please do not hesitate to contact us so that together we can create the safest and most useful installations at all times.

The experience of the company, a presence in the market since the 1960s, the availability of our own workshop for the construction and maintenance of the manufacturing tools, the practical knowledge of our technical office in the design and monitoring of installations from their launch and their own commercial network that covers the whole country all make Nueva Terrain a market leader in terms of material quality and technical support for customers.

The contact with the market at the start of our research and development projects, with a specific department within the company, as well as in the continuous improvement of our processes. Your opinion and suggestions are the driving force that leads us to update and improve our product catalogue. Without your collaboration neither the complete current range of our company nor its evolution since its beginnings in the 1960s would have been possible.



1. PLASTIC MATERIALS

- 1.1. Where do plastics come from?
- 1.2. What are plastics like "inside"?
- 1.4. Thermoplastics
- 1.5. Thermoset plastics
- 1.6. Elastomers
- 1.7. Terrain polybutylene (PB)
- 1.8. Essential characteristics of plastic materials

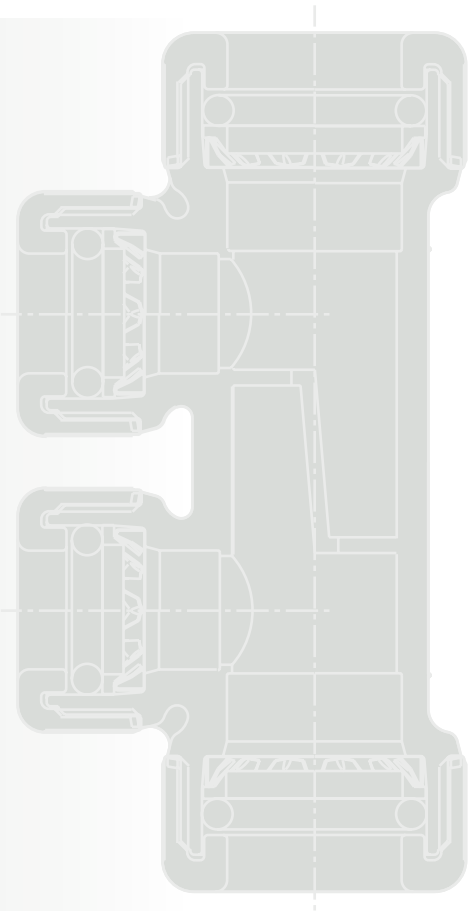

Plastic materials have been a true revolution for the industry in the 20th century with the widest range of applications. The following is a basic explanation of their origin and properties, focusing on the application and the product we provide.



1.1. Where do plastics come from?

Plastic materials are obtained as the result of a chemical transformation of natural products or by synthesis from organic compounds, whose main constituents are carbon (C) and hydrogen (H).

The basic materials for the production of plastics are natural products such as cellulose, coal, petroleum and natural gas, where the latter two are the most important.

In a refinery, distillation is used to separate petroleum into several fractions. As the different components of crude oil have different boiling points, heating in the fractioning tower provides gas, naphtha, fuel oil, etc. successively. The waste product from this process is asphalt.

All the fractions are constituted by hydrocarbons, which are differentiated by the size and the configuration of their molecules. The most important fraction for the manufacture of plastics is naphtha.

Naphtha is transformed by a process called cracking, in a mixture of ethylene, propylene, butylene and other light hydrocarbons.

1.2. What are plastics like "inside"?

Simply speaking we can say that plastics are formed through the binding of many constituent elements, identical or similar, assembled one by one, by chemical bonds. The unique element that when repeated forms plastics is the monomer: ethylene, propylene, butylene, ...

The repeated bonding of this element forms giant molecules called macromolecules. Despite their diversity, all plastics have the same structure: they are made up of macromolecules. The multiple physical and chemical properties of plastics depend on four factors: chemical structure, shape, size and layout of the macromolecules.

1.3. Classification of plastic materials

Depending on whether the macromolecules form linear or branched chains, form more or less closed meshes, or are erratic or partially aligned, the properties of the resulting product vary radically.

Linear and branched

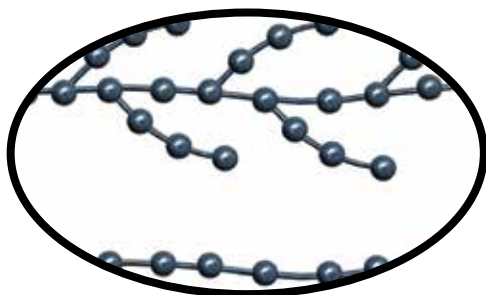

Cross-linked

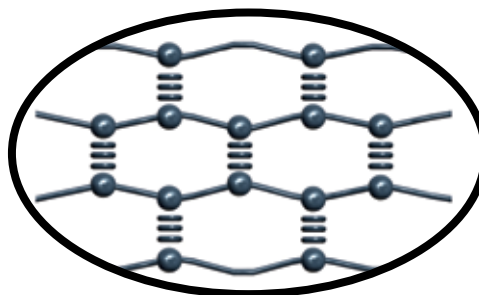

- **Thermoplastics:** polyolefins, vinyl chlorides, styrenes
- **Thermoset plastics:** thermoelastics (PEX or cross-linked PE), resins
- **Elastomers:** synthetic rubber



PLASTICS



THERMOPLASTICS

- **PB**
- HDPE
- PVC-U
- PVC-C
- PP-R
- PE-RT
- Etc.



THERMOSET PLASTICS

Also called
THERMOSETTING

Recycling is not possible in
the production process.

Not used in pipes for plumbing.



ELASTOMERS

- **EPDM** (Hot water)
- FPM (Gas)
- NBR (Fuel oil, oils)
- Etc.

PEx special case
HDPE → PEx
Cross-linked = Thermosetting



= *Recycling is not possible.*

1.4. Thermoplastics

They are composed of long filiform molecule with only two ends capable of reaction. Depending on the distribution of these molecules, filiforms may be:

- **Amorphous: erratic**, random structure. They are vitreous, transparent and generally fragile. Example: styrenes, polycarbonates, polyvinyl chlorides
- **Partially crystalline**: more or less ordered structure. They are translucent or opaque, but more resistant to heat than amorphous molecules. Example: polyolefins such as PB, PP, PE.

Amorphous

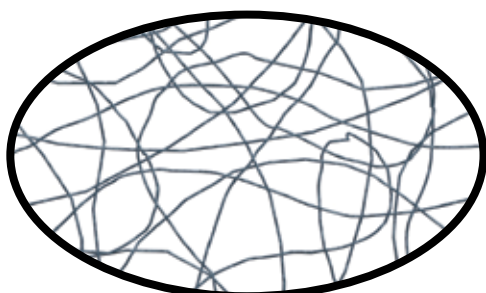

Partially crystalline

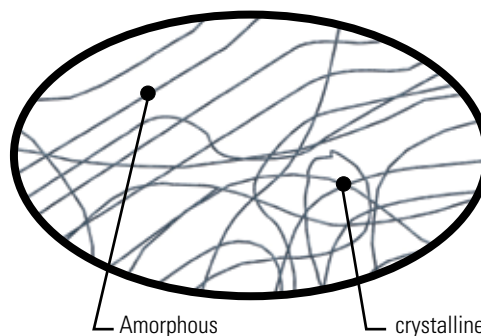

They can melt repeatedly and therefore they can be heat-converted numerous times, they can be welded, the proportion of crystallinity determines the density and the mechanical properties, under a high mechanical load they tend to flow and deform permanently, with increased temperatures their properties of resistance drop.

Partially crystalline thermoplastics, for example polyolefins, have a lower tensile strength, hardness, melting point and elastic modulus compared to amorphous plastics. In contrast, their resistance, elongation upon breakage and thermal expansion are higher. They are recyclable.

1.5. Thermoset plastics

They present cross-linked chains of the polymer that bond with the others forming dense, narrow meshes, with a closely cross-linked structure in all directions, making it very rigid and brittle. With the aim of improving their mechanical properties, they are reinforced with fibreglass, textiles and other loads.

They do not melt, they cannot be welded and they deform under load, but they regain their original shape afterwards. They cannot be heat transformed more than once, they do not present an elastic behaviour except in a relatively narrow range of temperatures, the number of cross-linked bonds determines their mechanical properties.

Thermoelastics are a particular case within thermoset plastics. Their base is a thermoset plastic whose structure is transformed in a spatially cross-linked molecule by bonds or bridges between the filiform molecules. Thus thermoelastics have properties similar to thermoset plastics but maintain practically the same hardness as the thermoset plastic from which it comes. The most well-known case is PEX. They are not recyclable.

Thermoset plastics

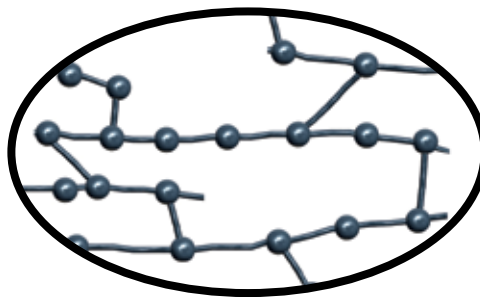

1.6. Elastomers

These are elastic plastics also called synthetic rubber. Their polymer chains are cross-linked by the action of vulcanising agents. Unlike thermoset plastics, their cross-linked mesh or grid is very broad, with few transverse links, which gives them their high elasticity. They are elastic even at low temperatures, very deformable under the action of a load, the number of cross-linked unions determines their hardness, they are not weldable and do not melt. They are not recyclable.



1.7. Terrain polybutylene (PB)

When 1-butylene (1-butene) is used as a constituent element and multiples are bound together forming filiform chains in a more or less ordered structure, polybutylene-1 (PB-1) is obtained. Their classification within plastics corresponds to a partially crystalline thermoset plastics.

1.8. Essential characteristics of plastic materials

Compared to the conventional materials used in pipe manufacturing, such as copper, plastic materials have the following general characteristics:

- **Low density:** lighter pipes.
The density of a body is the ratio between its mass (m) and volume (V).

$$\rho = \frac{m}{V} \text{ [kg/m}^3\text{]}$$

Densities of different materials:

PB	925 kg/m ³
PEX	940 kg/m ³
PP-R	900 kg/m ³
PVC-C	1550 kg/m ³
WATER	1000 kg/m ³
STEEL	7850 kg/m ³
COPPER	8890 kg/m ³

- **High chemical resistance and absence of corrosion:** the metals combine with the oxygen in the water causing their oxidation.
- **Resistance to hot water and pressure:** plastic materials such as PB fully meet the requirements of the standards concerning hot and cold drinking water pipes and heating.
- **Frost resistance:** Polybutylene pipes expand adapting to the increased volume of the water when it freezes.
- **Low thermal conductivity and, consequently, lower heat loss:** Thermal conductivity is understood as the energy flow through a material in relation to its thickness and the difference between the temperatures inside and outside of the pipe.

Thermal conductivity of different materials:

PB	0.19 W/mk
PEX	0.35 W/mk
PP-R	0.22 W/mk
PVC-C	0.16 W/mk
WATER	0.58 W/mk
STEEL	45 W/mk
COPPER	407 W/mk

- **Lower formation of water due to condensation on the exterior surfaces:** due to the lower thermal conductivity of this type of piping, the formation of water due to condensation requires more extreme environmental conditions and therefore a lower wall thickness of the insulation material can be used when this is necessary.
- **High elasticity:** The elastic modulus (E) is the relationship between the stress and the elongation of a material.

The smaller the elastic modulus, the more flexible the material, and in contrast, the greater the elastic modulus the more rigid the material will be upon bending.

Elastic modulus of different materials:

PB	450 MPa (N/mm ²)
PVC-C	3500 MPa (N/mm ²)
STEEL	210000 MPa (N/mm ²)
PP-R	900 MPa (N/mm ²)
PEX	1150 MPa (N/mm ²)
COPPER	120000 MPa (N/mm ²)

The greater flexibility of the material means that less stress is generated in the installation in the processes of thermal expansion, water hammer, impacts, freezes, etc., as well as the reduction of noise transmission in the system, resulting in more reliable and comfortable installations.

- **Abrasion resistance:** the abrasion resistance of plastic materials is approximately four times greater than that of metal materials.
- **Lower incidence of noise in the pipe-work:** due to its low elastic modulus, the transmission of noise caused in the water piping is lower in plastics than in metal piping.
- **Smooth surfaces:** the smooth interior surfaces cause a lower pressure drop.
- **Thermal expansion:** The linear thermal expansion coefficient α , indicates the elongation in mm of an initial length of 1 m due to a temperature increase of 1°K.



Thermal expansion of different materials:

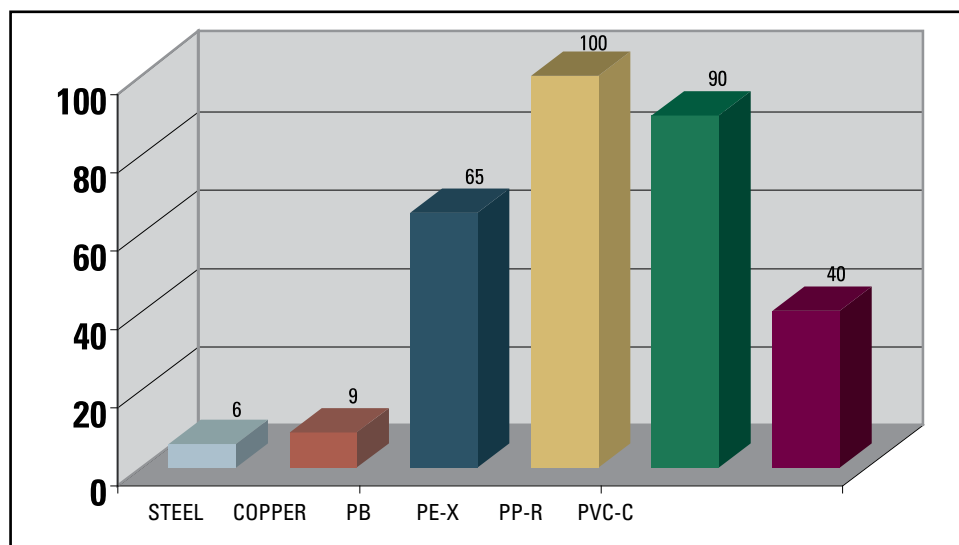

Expansion in mm calculated for a 10-m pipe and a temperature difference of 50°C

The changes in dimension caused by the temperature changes are greater in plastic materials than in metal, nevertheless, the low elastic modulus of PB-1 means that the forces generated by expansion are lower than they are in other plastic or metal materials, which brings many advantages to the installation (see Chapter 9).

- **Food Grade:** given its high chemical resistance, many plastic materials are suitable for use in the food sector. PB-1 is highly recommended for the transport of drinking water by organisations such as NFS, KIWA and KTW.
- **Fire safety:** plastic materials are flammable and their fire resistance classification is determined by standardised tests (see point 3.7).
- **Non-conducting material:** it should not be used as ground connection.
- **Resistance to sunlight:** in general, plastic materials are sensitive to ultraviolet rays and therefore must be properly protected (See section 3.9).

2. The History of Polybutylene-1 (PB-1)

2. THE HISTORY OF POLYBUTYLENE-1 (PB-1)

2.1. The raw material: Polybutylene-1 (PB)

2.2. PB-1 in the indoor distribution of drinking water

2.3. The Terrain PB-1 system in the indoor distribution of drinking water

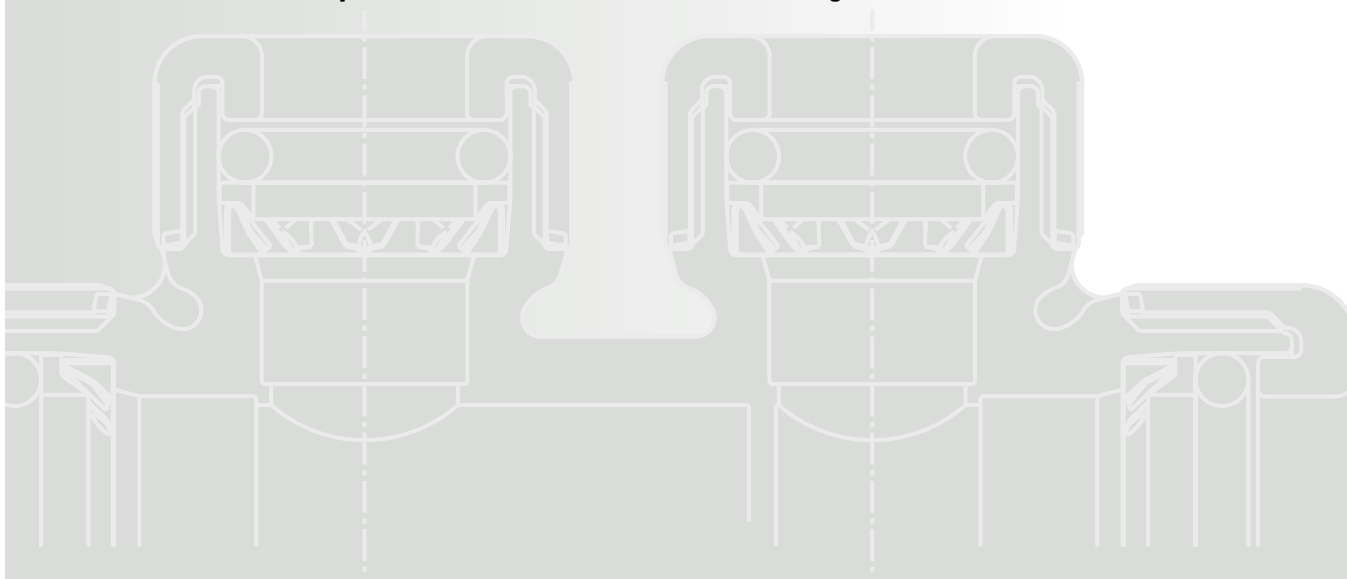

Polybutylene is a product that is practically exclusively for use in plumbing. Unlike other thermoplastics for the application, PP, PE, C-PVC, that have multiple and various target markets in construction, containers, automotion, etc., PB is an engineering plastic designed specifically for use in water pipework (which the producers define as Fluid Engineering).





2. The History of Polybutylene-1 (PB-1)

Polybutylene-1 was discovered in 1954 by the research team of professor Giulio Natta, awarded the Nobel Prize for Chemistry in 1963. The first industrial production, as well as its introduction in the European piping systems market dates back to the mid-1960s. The development of new applications and markets occurred in the 1970s and 80s. It was then that Terrain selected this raw material as the best one for our hot and cold water supply system, and began manufacture.

The initial producer of Polybutylene-1 was Shell, with a plant production in Taft, Louisiana, USA. The successive mergers of different plastics manufacturers have led the product to feature in the portfolios of Montell first, then Basell, and currently LyondellBasell. In the year 2002, in the face of significant growth in the consumption of PB, especially in the European market, a manufacturing plant for this raw material was opened in Moerdijk, Holland.

The ongoing research and development of the manufacturer of the raw material, as well as the experience of the transformers, has achieved a product with unbeatable characteristics for piping systems. PB is a plastic technical material in engineering, and is differentiated due to its characteristics and volume of manufacture from large-scale polyolefins, known as “commodities”.

2.1. The raw material: Polybutylene-1 (PB)

Polybutylene-1 is a partially crystalline thermoset plastic in the group of polyolefins. Its density is of same order as other thermoplastics such as PP and PE. Its optimum mechanical characteristics, its high chemical resistance and its dimensional stability with temperature make Polybutylene-1 the best choice for the manufacture of piping for transporting hot water.

PB-1 is manufactured through the polymerisation of butylene-1 (C₄H₈). The monomer is therefore a molecule of 4 carbon atoms with a double bond between the first and second carbon atoms. There is another isomer of Polybutylene, whose base molecule has the double bond between the second and third carbon atoms, called Polyisobutylene, with different final characteristics and applications.

In light of the chemical structure, Polybutylene-1 differs from Polyethylene and Polypropylenes only in the number of carbon atoms:

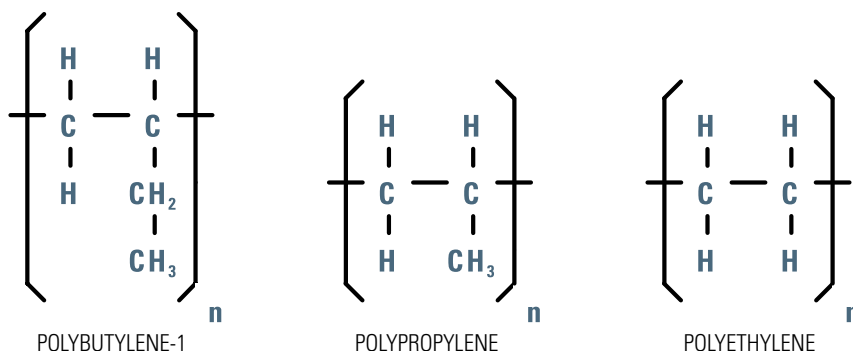

Polybutylene-1 has similar generic characteristics to Polypropylene: it is injectable, and therefore the fittings are manufactured in the same material as the pipe, and can be fusion welded, characteristics that are not shared by PEX, as it is a modified thermoset plastic. Unlike other thermoplastics for the same application, due to its excellent intrinsic properties Polybutylene-1 does not need additional processes such as copolymerisation, cross-linking or special additives to fulfil the characteristics necessary for the application. The raw material is unique and homogeneous, it does not need mixtures or subsequent processes that affect its final properties, as is the case of the cross-linking of PE to obtain PEX, the copolymerisation of PP-H to obtain PP-R and PP-RT and the overchlorination of PVC-U to obtain PVC-C.



Like PP and PE, PB is a non-polar plastic: its surface is not subject to penetration or dissolution. This behaviour means that PB pipes and fittings cannot be joined using adhesive. Nevertheless mechanical joints and welding (socket fusion) can be used. Its high flexibility, even at low temperatures, and its stability at high temperatures make PB-1 a product of the future, and not only in distribution networks in homes but also in industrial applications.

2.2. PB-1 in the indoor distribution of drinking water

The objective of Nueva Terrain is to satisfy the highest quality requirements with its Terrain SDP system, and this has justified the use of especially harsh selection criteria for the final selection of PB-1. The decision was based on the latest advances in its research and development, in-depth knowledge of the field of plastics as well as supplementary options so that the system evolves with future perspectives in installation and joint techniques.

As a consequence of in-depth studies and tests both in our own laboratories and in independent organisations, the conclusion was reached that the optimum raw material for our Terrain SDP system was PB-1, a partially crystalline polyolefin thermoplastic with a high long-term performance and a high resistance to flow at high temperatures, properties that are essential for the interior hot and cold water installations as well as for heating.

Polybutylene, the universal plastic material that allows joints by fusion welding and by mechanical fittings, combining numerous favourable characteristics such as:

- Dimensional stability and high long-term performance
- High resistance to plastic flow, significant for the watertightness of compression joints.
- Resistance to hot water.



- Stabilisation against alterations due to ultraviolet rays during handling and installation.
- Pigmentation against the formation of algae.
- High flexibility, even at low temperatures.
- Low embrittlement temperature.
- High resistance to impact and water hammer.
- High resistance to abrasion.
- As a consequence of its high resistance to high temperatures compared to other plastics, it permits lower wall thicknesses for identical usage profiles which, in addition, is converted into larger internal transport diameters for the same external diameter, lower velocities for the same flow, lower head losses and a lower pipe weight per metre.
- Excellent energy audit compared to other materials makes it the product with the lowest environmental impact among those of the same application.

2.3. The Terrain PB-1 system in the indoor distribution of drinking water

The Terrain SDP system of pipes and fittings manufactured in PB for the distribution of hot and cold water and heating offers the following advantages:

- Absence of corrosion
- Absence of scaling
- High stability upon ageing even at high temperatures
- Quick, easy and safe joints
- Wide range of fittings
- Possibility of complete projects in the same material and system, with diameters from D15 mm to 160 mm
- Safe and hygienic
- High pipe flexibility, leading to quick and easy assembly and installations
- Rational and economical installation techniques
- Technological knowledge of Terrain in the manufacture of piping and fittings and in the installation of plastic materials
- Advice and technical support on hand for the customer, aimed at each specific case.

3. Polybutylene characteristics and PB piping system

3. POLYBUTYLENE CHARACTERISTICS AND PB PIPING SYSTEM

3.1. Polybutylene characteristics

3.2. Comparison of physical characteristics between materials

3.3. Noise transmission

3.4. Water hammer

3.5. Oxygen permeability

3.6. Legionella

3.7. Fire

3.8. Pipe bending

3.9. Oxidising agents

3.10. Cryogenic behaviour

3.11 Embedded pipes

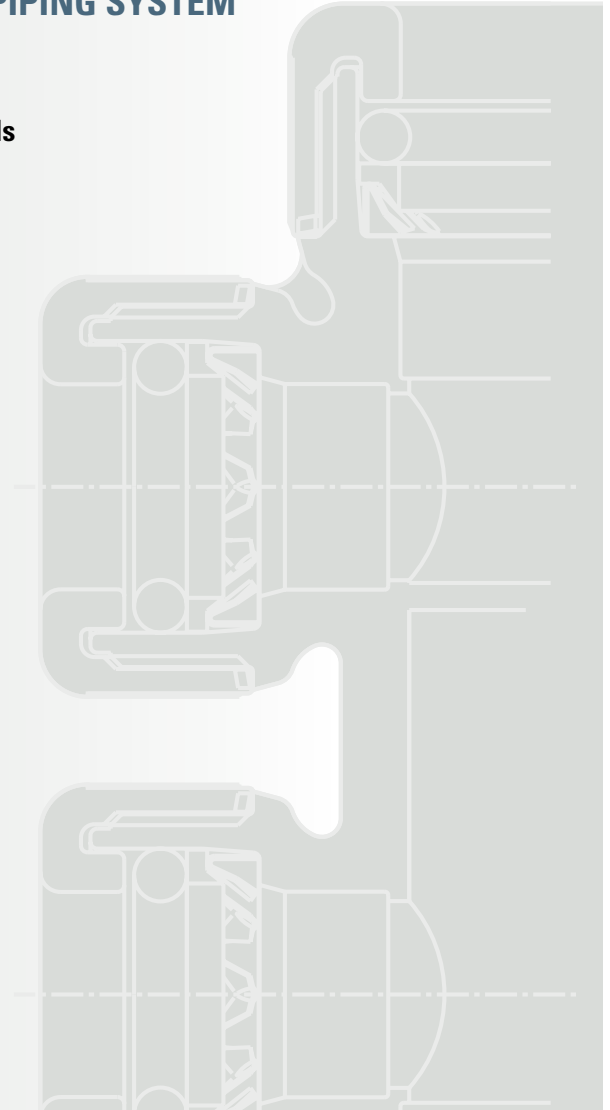



3.1. Polybutylene characteristics

External diameter	EN ISO 15876	See EN ISO 15876-2; Section 6.2.1	
Wall thickness	EN ISO 15876 See	EN ISO 15876-2; Section 6.2.2	
Colour		Grey – RAL 7001	
Density	ISO 1183	925	kg/m3
Flow index	ISO 1133 – 190°C/2.16 kg	0.35	dg/min
Carbon black content	--	<0.1	%
E.SCR. (50°C/10% Igepal C0630 solution)	ASTM D1693	15000 h No fault	H
Elastic limit	ISO R 527	20	MPa
Stress rupture	ISO R 527	35	MPa
Elastic modulus	ISO 178	450	MPa
Deformity upon breakage	ISO R 527	300	%
Longitudinal shrinkage	EN 743	< 2	%
Hardness	ISO 868	60	Shore D
Resistance to impact	ISO 180	Without rupture 40	KJ/m2 at 20°C KJ/m2 at 0°C
Coefficient of thermal expansion	ASTM D696	1.3 · 10 ⁻⁴	m/mK
Thermal conductivity	ASTM C177	0.19	W/mK
Melting point	DSC	130	°C
Vicat softening temperature	ISO 306	120	°C
Glass transition temperature	DMTA	-16	°C
Hydrostatic resistance to breakage	EN 921	See EN ISO 15876-2 – Section 7	
Internal hydrostatic pressure	EN ISO 9080	See EN ISO 15876-2 – Section 4.2	
Speed of sound	-	620	m/s
Toxicity	Non toxic – According to stringent organoleptic and migration tests by various independent institutes		
Bacteriological analysis	KIWA (Holland) and the German water and gas association (DVGW). Technical guide W270	It does not present growth of microorganisms after 6 months of immersion. The material meets the requirements.	

3.2 Comparison of physical characteristics between materials

PROPERTY	VALUE						UNITS
	PB	PEX	PP-R	PCV-C	Copper	Steel	
Density	925	940	900	1550	8890	7850	kg/m3
Thermal conductivity	0.19	0.35	0.22	0.16	407	45	W/mK
Coef. of thermal expansion	0.13	0.20	0.15	0.08	0.018	0.012	mm/mK
Elastic modulus	450	1150	900	3500	120000	210000	MPa
Resistance to pressure 20° (1)	21.9	15.2	13.9	20.05			bar
Resistance to pressure 70° (1)	10.15	7.12	4.31	8.88			bar
Speed of sound	697	1106	1000	1503	3674	5172	m/s
Expansion stress (2)	480	2245	1595	2734	8468	25437	N
Creep resistance (3)	6.75	32.5	13.5		19.31	18.00	%
Water hammer (4)	2.99	4.73	5.12	8.50	31300	32900	bar
Sustainability (energy consumption) (5)	6900	16000	15300	15000			MJ

- (1) Resistance in accordance with standard at the defined temperature (20 or 70°C) and 50 years for an S5 pipe (e.g. 25x2.3 mm) of different materials.
- (2) Stress generated between two fixed points due to a temperature increase of 50°C in the material (e.g. pipe d25 mm). The dimensions of the piping in each material used for the calculation were: PB 25x2.3, PEX 25x2.8, PP-R 25x3.5, PVC-C 25x2.8, Copper 22x1.2, Steel 26.9x2.65.
- (3) Elongation in % at a uniaxial creep stress of 8 MPa/23°C 10000 h.
- (4) Overpressure due to instantaneous shut-off in a commercial pipe of Ø25 mm with a water velocity of 1.5 m/s.
- (5) Energy consumed for the manufacture of each piping system according to a VENOB study by the University of Berlin.

FEATURES	PB	PP-R	PEX	CPVC
Resistance to temperature and pressure	****	**	***	**
Flexibility	****	**	***	*
Creep resistance	****	***	**	
Impact resistance	****	**	***	*
Thermal stress in installations	****	**	***	*
Sustainability of the system	****	***	***	***
Speed of the joint small Øs	****	*	***	**
Availability of joint with large Øs	****	****	**	***

**** Excellent
 *** Good
 ** Average
 * Poor

Explanation of the main qualities of PB as a material for plumbing and heating systems:

FEATURES	APPLICATION	POLYBUTYLENE
Density	Lower weight: facilitates handling, decreases the cost and reduces the environmental impact of its manufacturing process.	Plastic systems in general benefit from its lightness compared to metal.
Thermal conductivity	It reduces heat loss and the possibility of condensation on the cold side.	Again it is a typical characteristic of plastic systems, where PB has the lowest value.
Thermal expansion	The expansion of plastic materials due to temperature changes is greater than that of metal: It must be taken into account for their compensation.	Although PB has a lower expansion than other plastic materials, these expansions must always be taken into account.
Elastic modulus	The much lower rigidity of the piping (lower elastic modulus) facilitates its usability in construction, and reduces the generation of stress linked the functioning of the installations: water hammer, fixed points and expansion, etc.	It is the most elastic material of all those used for this application, and therefore it is the most manageable and generates the lowest stress.
Resistance to pressure and temperature	The main characteristic that defines a piping system is its resistance to temperature and pressure. This information is characterised in the regression curves of the material, the DNA of the pipe.	Polybutylene is the material with the best pressure resistance according to the temperature. This leads to lower thicknesses for the same required resistance, or a better resistance for the same thickness.
Creep resistance	The creep represents the deformity of the material over the course of time under constant load. It is fundamental in compression joints to ensure the dimensional stability of the pipe.	PB has minimum creep, preserving its dimensions under constant load.
Speed of sound	As the material is very elastic, the transmission of sound and therefore noise through the physical medium made up of the piping network is far lower than that of other materials.	It is the material that best insulates against noise transmission.
Expansion stress	The low elastic modulus of the material means that the stress generated by the expansion between fixed points of the installation is much smaller.	PB does not cause problems in installations due to expansion stresses.
Water hammer	The pressure peaks caused by instantaneous shut-offs of fluid flow are sources of problems in rigid piping systems.	PB is excellent at absorbing the stress associated with water hammer in installations.
Sustainability	Sustainable construction requires systems manufactured with a lower consumption of resources.	Polybutylene is the system that consumes less resources in its manufacture and causes less harm to the environment.



3.3. Noise transmission

The characteristics of thermoplastics, and fundamentally those of Polybutylene, make it an excellent acoustic insulator for the installation, especially compared to metal materials. Thus the noise associated with plumbing and heating installations, due to channelling the fluid through the piping and fittings and water hammer, as well as the thermal movements caused within them are avoided.

The material transmission of sound through the piping system depends directly on the speed of sound in each material. The speed of sound depends on the material through which it is transmitted and is related to the elastic modulus and the density of the product, according to the formula:

$$V_s = \sqrt{\frac{E}{\rho}}$$

Results for each material:

MATERIAL	ELASTIC MODULUS (MPa)	DENSITY (kg/m ³)	SPEED OF SOUND (m/s)
PB	450	925	697
PEX	1150	940	1106
PP-R	900	900	1000
PVC	3500	1550	1503
Steel	210000	7850	5172
Cu	120000	8890	3674
Rubber	90	900	316

3.4. Water hammer

A column of water in movement within a pipe contains stored kinetic energy, according to its mass and velocity. Due to the fact that water is an approximately incompressible fluid, this energy cannot be absorbed when a valve is closed suddenly. The result is a high instantaneous overpressure, generally known as water hammer. Problems associated with water hammer are one of the most frequent causes of failures in metal pipes, due to their rigidity. In plastic piping, its low elastic modulus, especially in the case of PB, means that the pressures generated are very low and, therefore, we can say that they generally do not cause problems in installations.

Five factors determine the severity of water hammer:

- Flow velocity
- Elastic modulus of the pipe material
- Internal pipe diameter
- Pipe wall thickness
- Valve closure time

There are different mathematical models that make a theoretical calculation of the water hammer effect. The most commonly used are those based on the Allievi equation, and can be summarised as follows for a quick valve closure time and water as the fluid handled:

$$C = \frac{9900}{\sqrt{47.3 + \frac{k}{E} \cdot \frac{D}{e}}} \implies \Delta P = \frac{C \cdot V}{g}$$

Where: **C** is the speed or velocity of propagation of the pressure wave (m/s)

k = empirical calculation constant with a value of 10^5

E = elastic modulus of the pipe material (MPa)

D = internal pipe diameter (mm)

e = pipe wall thickness (mm)

ΔP = overpressure produced (m.wc) (1 m.wc= 0.098 bar)

V = velocity of the water (m/s)

g = acceleration due to gravity = 9.81 (m/s²)

The low elastic modulus of Polybutylene-1, combined with a low wall thickness, gives rise to an overpressure due to water hammer far below that of other materials, and perfectly manageable due to the resistance of the piping system. For example, the resulting values for a pipe with an external diameter of 25 mm for different materials and a flow velocity of 1.5 m/s are provided below (evidently the thicker plastic pipes in this example would provide a lower flow).

	E (MPa)	D (mm)	e (mm)	V (m/s)	ΔP (bar)
PB	450	25	2.3	1.5	2.99
PEX	1150	25	2.8	1.5	4.48
PP	900	25	3.5	1.5	5.12
PVC-C	3500	25	2.8	1.5	8.54
Steel	210000	25	1	1.5	19.31
Cu	120000	25	1	1.5	18.00

The overpressure produced by water hammer must be added to the working pressure of the installation.

3.5. Oxygen permeability

It is accepted that the metal components of piping installations for water supply and heating can rust due to the oxygen content dissolved in the water carried. In open water supply circuits, there are various ways for oxygen to enter, and it is understood that it is not necessary to waterproof the plastic piping. Nevertheless, in closed circuits such as those of heating, oxygen should be minimised by the low permeability of plastic piping. For this application, composite piping with a layer of oxygen-impervious material (generally EVOH or aluminium) is used for this application.



Nueva Terrain has a composite pipe that is impervious to oxygen with 5 layers: PB/Adhesive/EVOH/Adhesive/PB. Piping made in this way is absolutely equivalent to single-layer pipes in terms of use and application. Unlike other composite piping that alter the function of the pipe, the composite piping by Nueva Terrain can be connected using the same push-fit fittings from the catalogue. As the EVOH layer is at the centre of the pipe, it is not altered by external factors, preserving its waterproof nature for its whole useful life, unlike those with the external layer.

As a comparison and as an indicator of the real values of oxygen permeability of each pipe, a specific test was performed at the Dutch institute KIWA, where they obtained the results set out below, for water at 40°C:

Material	PB	PE-Xa	PE-Xb	PE-Xc	PP-R80	PE-Xc-AI	PB-EVOH
g ⁰² /m ³ -day	1.2	3.87	3.22	7.86	2.82	<0.0003	<0.0003

Project number: 30.5112.070.001

View under the microscope of a section of piping with detail of the 5 layers

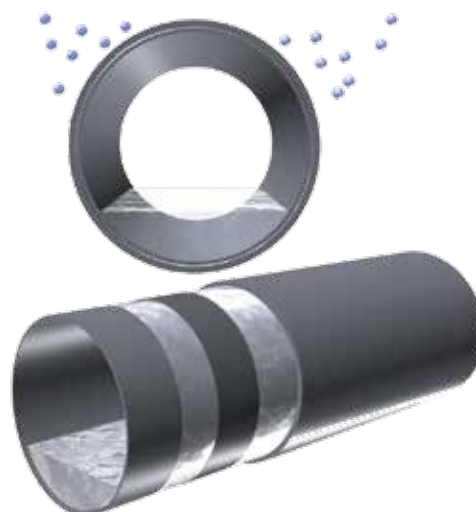
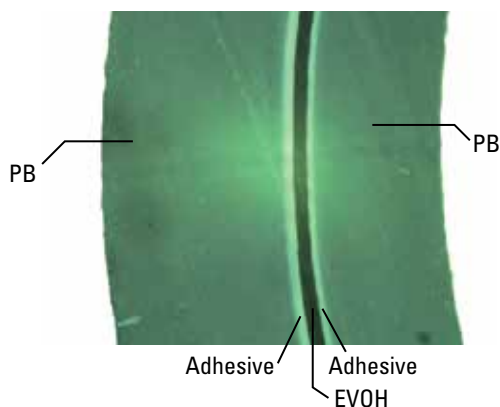

3.6. Legionella

Legionella is a bacteria occasionally naturally present in water distribution networks, and presents a potential danger to the health of the users of these installations. The factors to combat to prevent the reproduction of this bacteria in piping systems in buildings are its reproduction temperature and the formation of a biofilm as a substrate for the feeding and colonisation of the bacteria.

The reproduction temperature of Legionella is between 20 and 50°C, so water temperatures within this range must be avoided. On the other hand, the formation of a biofilm is aided by the accumulation of stagnant water, the temperature within the aforementioned range, the roughness of the piping and the possible corrosion of its metal.

The annihilation temperature of Legionella is established at 70°C, and this is why thermal disinfection treatments require fluid to be heated to this temperature. The international standards for production consider this working temperature for this application, where class 2 is defined as applicable (see chapter 5). Therefore, Nueva Terrain recommends specifying the design of the installations to withstand this temperature of 70°C.

The best choice of material (PB is optimum in this sense), as well as a good design and proper maintenance of the installation, will keep problems at bay.

PB piping, due to its low roughness, the lack of metal corrosion, and its optimum resistance at 70°C (annihilation temperature of the bacteria) are ideal for preventing Legionella problems. They are, in addition, suitable for annual chemical disinfection treatments (30 ppm of Cl at 30°C, 6 bar and for 2 hours), according to tests performed by the manufacturer of the raw material, Basell, in independent laboratories.

3.7. Fire

Polybutylene, like the other organic polymers used for this application, burns. It is difficult to cause it to ignite, but it is classified as fuel, although not highly inflammable. Its behaviour is equivalent to that of other polyolefins.

When Polybutylene-1 is heated, fusion begins at around 130°C, and decomposition at approximately 300°C, releasing low-molecular-weight volatile hydrocarbons. Flames or heat sources can cause the latter to ignite. Once ignition has occurred, the heat generated is sufficient to continue the fire, provided there is enough oxygen.

These observations are general and theoretical, as the actual conditions are not ideal and are not generally predictable. It depends on many factors, such as the location, the availability of oxygen and the presence of other inflammable materials. In total combustion, if there is enough oxygen, the main products of combustion are carbon dioxide and water, as well as small residual products of decomposition and oxidation, usually irritants, in very low concentrations.

As it is a polyolefin, as mentioned above, the characteristics of inflammability and fire resistance of PB-1 are similar to those of Polyethylene and Polypropylene.

In tests performed at Springborn Laboratories in Enfield, Connecticut, Polybutylene-1 met the requirements of the Underwriters Laboratories test, regarding its fire resistance, and was classified as material **UL94HB**.

PB-1 is classified in accordance with **Class IV.2** (normal inflammability) in the recommendations by VKF (Association of Canton Fire Insurances).

In accordance with the German standard DIN 4102-1, Polybutylene-1 belongs to fire protection **Class B2**.

The limiting oxygen index for combustion for PB-1, in accordance with the standard ASTM D2863-11, is **17.5**.

3.8. Pipe bending

PB piping, due to its low elastic modulus and the lower thickness needed for the same resistance, is the most flexible system on the market, and therefore it is easier to handle and bend without heating.

Like other thermoplastics, the piping must never be bent excessively to avoid extreme stretching of the external generatrix of the curve.

In this regard, we do not recommend bends with a curve radius less than 8 times the diameter of the pipe when rolled, 30 times the diameter if the bend is in the opposite direction to that of the roll and 10 times in straight stretches of piping.

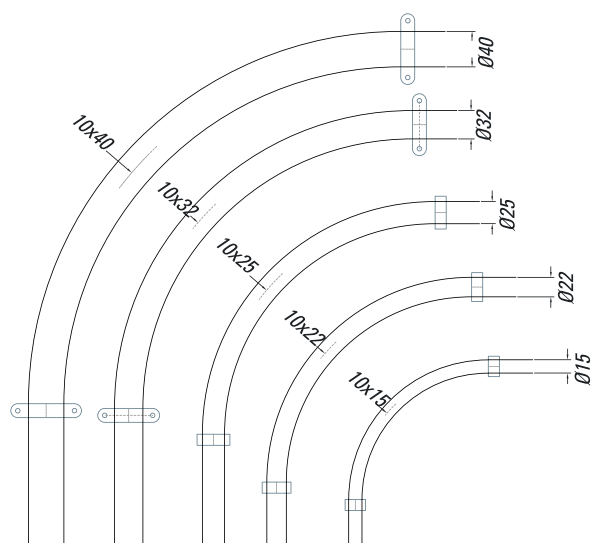

Maximum curvature of straight pipes

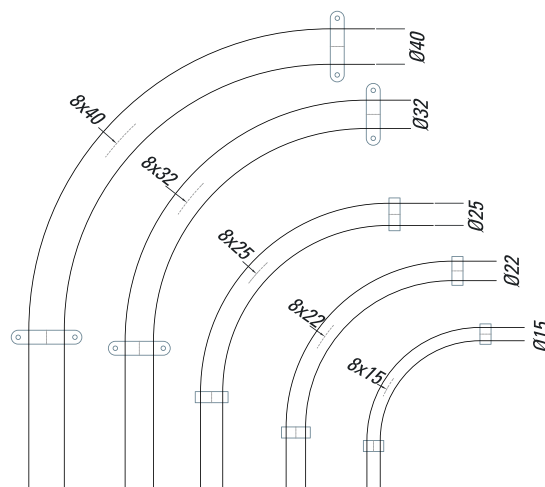

Maximum curvature of pipes in rolls

ATTENTION: Under no circumstances, in addition to being unnecessary, must the pipes be bent using an external heat source.

3.9. Oxidising agents

Polybutylene, like other polyolefins, is highly resistant to solvents and chemical products, with a few exceptions. PB-1 can be attacked by non-polar organic solvents, such as benzene, toluene, carbon chloride, etc. In any event, consult the table of resistances to the chemical agents found in Annex 8 of this manual for specific applications.

Note: the table of resistances to chemical agents only refers to PB-1 but not to other possible components of the installation, such as EPDM (flexible gaskets), brass, etc. Please contact us to verify the possibility of using our system for chemical agents.

Chlorine is a harsh oxidising agent for both Polybutylene and other polyolefins. The percentages that are found in the drinking water networks (< 1ppm) are not harmful, nor are the annual treatments performed to prevent the apparition of Legionella bacteria.

The ultraviolet rays in sunlight can cause or accelerate the deterioration of the material. **The product must be shielded from direct sunlight**, in storage as well as in its final use. In the case of outdoor use, it should be sheathed or painted to protect it.

If it is painted, it is preferable to use emulsion paints (water-based) to paint Polybutylene. In any event, oil-based lacquer paints can be used with a primer. Do not use cellulose-based paints, paint strippers or solvents.

Before painting, ensure the surfaces are clean, dry and free of grease.

Refer to the composition of the paint or consult a specialist in case of doubt.

3.10. Cryogenic behaviour



The frozen pipe dilates without breaking, avoiding water leakage in installations exposed to low temperatures.

Polybutylene is a very suitable material for cooling and air conditioning. It maintains its flexibility better than other materials at temperatures below zero and resists the families of glycols used as antifreeze. The tests performed in our laboratories indicate optimum behaviour and resistance in these conditions.

The glass transition temperature is -16°C , with pressure tests performed at temperatures of up to -40°C . Its flexibility means it can withstand the freezing of the water carried without rupture, unlike more rigid materials that break in the event of freezes.

3.11. Embedded pipes

We always recommend using protection for piping that is embedded, whether metal or plastic. The reasons for this are different in each case:

- **Metal pipes for cold water:**
 - To protect them from the harm caused by water that condenses
 - To avoid noise
- **Metal pipes for hot water:**
 - To protect them from damage to the party walls and piping system due to the expansion stress
 - To avoid noise
- **Plastic piping for hot and cold water:**
 - To protect the piping from possible damage (scrapes, punctures, etc.)

Although it is not recommended, "bare" PB-1 piping could be embedded provided care is taken that there are no sharp edges or abrasive areas that could damage it. It is also necessary to ensure that pipes are embedded deep enough that the expansion forces cannot break the surface of the wall or floor.

The best way to protect PB-1 piping when it is in an embedded installation is to use a conduit.

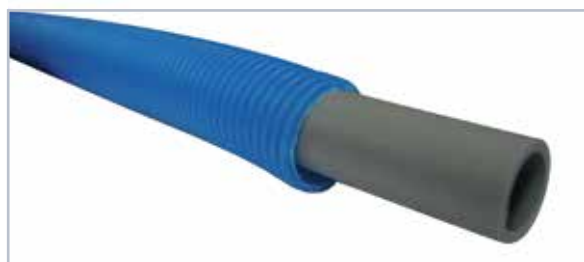

4. Resistance to the temperature and pressure of the piping system



4. PRESSURE AND TEMPERATURE RESISTANCE OF THE PIPING SYSTEM

- 4.1. Calculation procedure for the working pressure of a pipe
- 4.2. Calculation for the design pressure of a pipe
- 4.3. Regression curve
- 4.4. Safety factor
- 4.5. Calculation example
- 4.6. Pipe series
- 4.7. Standard pressures obtained from this process
- 4.8. Dimensional equivalences

Beyond the advantages that the above characteristics of Polybutylene entail compared to other materials, the main property that separates PB from other materials is its high resistance to temperature and pressure in comparison with other plastics used for this application.



4. Pressure and temperature resistance of the piping system

The mechanical characteristics of the material, that are objectively reproduced in the production standard, explains the better resistance of the pipe with the same thicknesses, or the need for lower thicknesses for the same design pressure chosen for the installation. A summary of the calculation process of the design pressure for a pipe of any material, at a given temperature and for a certain useful life can be found below.

Remember that plastic piping is always characterised by these three variables: **pressure, temperature and useful life**.

Unfortunately, a definition of the piping with only two of these characteristics can be found on the market, or worse, with all three but not consistently: "the pipe withstands 95°C and 10 bar", but omitting the fact that this is not at that temperature.

4.1. Calculation procedure for the working pressure of a pipe

The data that it is needed and the equations and graphs used for the calculation of the working pressure are the following:

- Calculation parameters: pipe (diameter, thickness and material), working temperature and useful life
- Equation for the pipe's resistance to pressure → Lamé's equation
- Equation for the stress of the pipe material according to the temperature and useful life → Regression curves
- Application of the safety coefficients

4.2. Calculation for the design pressure of a pipe

The equation with which the hydraulic pressure that a pipe can resist is calculated according to the hydrostatic stress of the material of which it is manufactured is very straightforward:

$$P = \frac{2 \sigma e}{D - e}$$

Where: **P** is the pressure that the pipe can withstand (MPa)
σ is the stress of the material (MPa)
D is the external diameter of the pipe (mm)
e is the thickness of the pipe (mm)



It is the Lamé equation that is the result of the calculation of the resistance of the materials of a cylindrical element with internal pressure. The problem therefore lies in the identification of the hydrostatic stress of the material, that is not a unique value, but depends in the temperature and useful life of the pipe. This information is included in the regression curves of each material, that are provided objectively in the standards of each product.



4.3. Regression curve

As mentioned in the previous chapter, the regression curve of a plastic material is the graph that gives us the evolution of the resistance of this material according to the temperature and useful life. This curve is obtained by means of functional internal pressure tests at independent institutes that are then included in the standards of each piping system for the calculation of the nominal pressures of each pipe. It is, therefore, the “identity card” that identifies each material and, therefore, each pipe.

There is a calculation standard for these curves, ISO 9080, which is applied to all of the products.

The value obtained from the graph, given a temperature and a useful life, is the **working stress** of the material, σ , generally expressed in Megapascals (Mpa) [1 Mpa = 10 bar]. With this data applied to the formula above, we obtain the expected rupture pressure for the pipe at those conditions of temperature and useful life.

The following graph shows the regression curve for PB included in its applicable international standard, EN ISO 15876, and a point can be obtained on it according to the example in the final section.

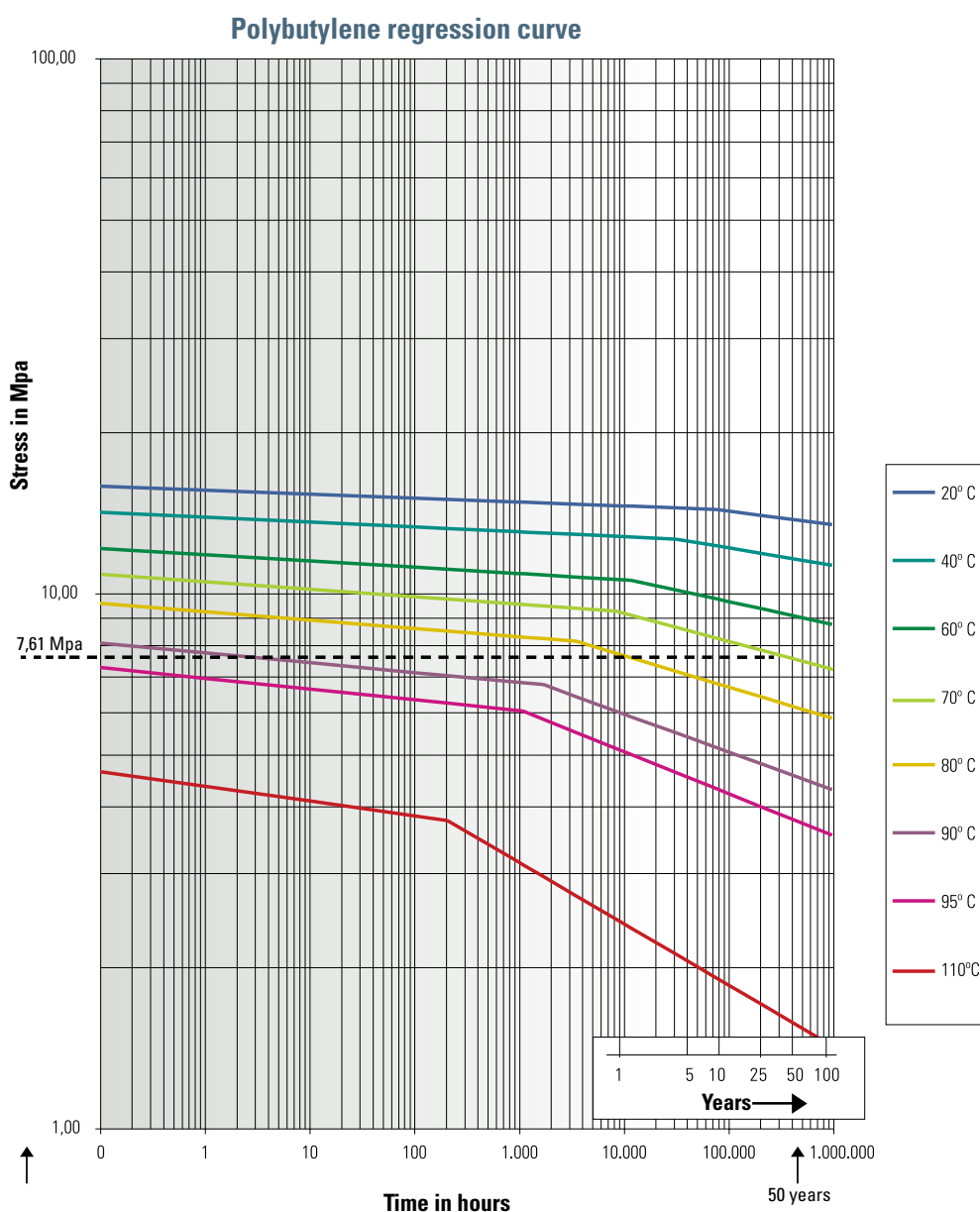

Reference curve for the expected resistance of Polybutylene according to the standard UNE-EN ISO 15876:2004.

4.4. Safety factor

As materials engineering does not allow or consider the design of installations at the ultimate tensile stress, a safety coefficient must be applied to the hydrostatic stress obtained, to finally calculate the design pressure of the pipe. It is a simple correction factor that is applied directly and proportionally, and is included in the standards of the aforementioned materials. It is a function of the confidence limit obtained in the statistical approximation of the regression curve, according to the empirical data for breakage of the internal pressure tests performed.

The coefficients that are applied to each material according to the calculation temperature and standard are:

Coefficients according to the temperature

MATERIAL	T _D	T _{cold}	T _{max}	T _{mal}
PB	1.50	1.25	1.30	1.00
PEX	1.50	1.25	1.30	1.00
PP-R	1.50	1.40	1.30	1.00
PE-RT	1.50	1.25	1.30	1.00
PVC-C	1.80	2.50	1.70	1.00

T_D: Design temperature

T_{cold}: Cold water temperature, up to 25°C

T_{max}: Maximum design temperature, maintained only for short periods

T_{mal}: Malfunction temperature.

4.5. Calculation example

As an example, we are going to obtain the design pressure for specific conditions and piping according to the procedure explained. Thus the user will be able to obtain same the value for any other condition and material.

Working conditions: 70°C – 50 years – Safety factor 1.5

Piping: Diameter: 25 mm – **Thickness:** 2.3 mm – **Material:** Polybutylene

Step 1:

The hydrostatic stress of the material at the conditions defined entering the regression curve of PB: point of intersection of the curve of 70°C and the vertical of 50 years on the x-axis. The value obtained is: 7.61 MPa, corresponding to the stress without the safety coefficient in those conditions.

Step 2:

Apply the safety factor specified in the standard for the working temperature, 1.5. You have the stress design, which shall be:

$$\sigma_d = \frac{7.61}{1.5} = 5.07 \text{ MPa}$$

Step 3:

Apply the equation that relates the pipe geometry and the material stress to the working pressure, obtaining

$$P = \frac{2 \cdot \sigma \cdot e}{D - e} = \frac{2 \cdot 5.07 \cdot 2.3}{25 - 2.3} = 1.03 \text{ MPa} = 10.3 \text{ bar}$$

Therefore we have a working pressure of 10.3 bar at 70°C and 50 years for the PB pipe of 25x2.3 mm.



The product standards of the different plastic materials include the equations that govern the regression curves. If you want to obtain a precise result, it is possible to solve the logarithmic equations proposed.

4.6. Pipe series

The dimensions of the piping in terms of diameter and thickness are standardised to ensure the compatibility of materials and the existence of pipe series (S) that ensure the same resistance.

These piping “series” are those that have the same diameter and thickness ratio, and therefore the same resistance for the whole range of diameters. Due to this the set of pipes is usually defined by its S or SDR value, corresponding to the same resistance.

The SDR value represents a dimensional relationship and the S value a relationship between the stress of the material and the working pressure. Both are also directly related, according to the following equations:

Where: **e** is the thickness
D is the external diameter
S is the pipe series
SDR is the standard dimensions ratio

$$\text{SDR} = \frac{D}{e} = 2 \cdot S + 1$$

$$S = \frac{D - e}{2 \cdot e} = \frac{\text{SDR} - 1}{2}$$

For the same pipe diameter, the greater the thickness, the lower the values of S and SDR. Piping of the same material and S (and SDR) value but with different diameters has the same internal pressure resistance.

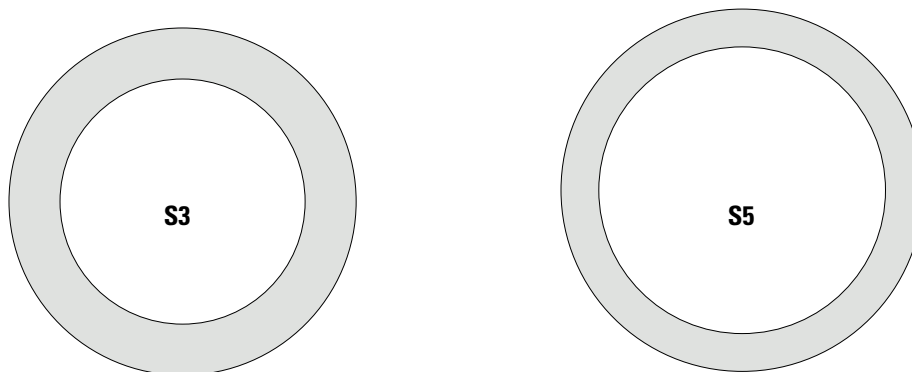

Comparison of piping of the same diameter and different S (and SDR) values. The greater the S value, the lower the thickness.

Cold water piping used to relate this resistance to its NP or nominal pressure value, which was evidently related to each piping series.

For the application of domestic hot water this value loses its relevance, as the resistance of each temperature for hot water (60 or 70° C) is unrelated to this value of NP.

* NP= nominal pressure at 20°C and 50 years, including the safety factor.

In the following chapter we will explain the resistance of each pipe for these applications, which is provided in the standard for each material with a calculation equivalent to that explained.

Frequently, the piping is identified by its S or SDR value, and diameter, without needing to specify the thickness that given in the standardised tables of dimensions.

Thus, the Terrain SDP Polybutylene piping catalogue corresponds to the piping in the series S 5 or SDR 11 (except the lower diameters 15, 16 and 20 mm). See the tables below.

Characteristics of the pipe for push-fit joints of Nueva Terrain system

Pipe classification according to UNE EN 15876		Class 2 (70°C, 10 bar, 50 years, C 1.5)								
(old NP in bar)		27.2 bar					21.8 bar			
Piping series		4					5			
SDR		9					11			
External pipe diameter	mm	15	16	20	22	25	28	32	40	50
Wall thickness	mm	1.7	1.8	2.3	2.0	2.3	2.5	2.9	3.7	4.6
Internal pipe diameter	mm	11.6	12.4	15.4	18.0	20.4	23.0	26.2	32.6	40.8

Characteristics of the piping for socket fusion and butt fusion joints of the Nueva Terrain system

Pipe classification according to UNE EN 15876		Class 2 (70°C, 10 bar, 50 years, C 1.5)											
(old NP in bar)		27.2						21.8					
Piping series		4						5					
SDR		9						11					
External pipe diameter	mm	16	20	25	32	40	50	63	75	90	110	125	160
Wall thickness	mm	2.2	2.3	2.3	2.9	3.7	4.6	5.8	6.8	8.2	10.0	11.4	14.6
Internal pipe diameter	mm	11.6	15.4	20.4	26.2	32.6	40.8	51.4	61.4	73.6	90.0	102.2	130.8

As mentioned above, all the piping of the same series has the same resistance, as the Lamé equation can also be formulated in the following way:

- P**: internal pressure (MPa)
- σ**: hydrostatic stress (MPa)
- S**: piping series
- D**: external pipe diameter (mm)
- e**: pipe thickness (mm)

$$P = \frac{2 \sigma e}{D - e} = \frac{\sigma}{S}$$

As S is a dimensionless value, the units used for the stress σ are those obtained for the pressure (P)



4.7. Standard pressures obtained from this process

The standards for each product establish the working pressures for each piping series and application (domestic hot water or heating) according to the previous calculations. The table below summarises the working pressures for each class of application and material, according to the aforementioned standards, for the piping series S5:

Working pressures

APPLICATION	CLASS	PB	PEX	PP-R	PE-RT I	PP-RTC	PVC-C
Domestic hot water at 60°	Class 1	10	6	6	6	6	8
Domestic hot water at 70°	Class 2	10	6	4	4	6	8
Heating at low temperature	Class 4	10	8	6	6	6	-
Heating at high temperature	Class 5	8	6	-	4	4	-

* Pressures in bar.

* Categories 4 and 5 are not applicable for PVC-C.

4.8. Dimensional equivalences

In accordance with the above, and in view of the availability of standardised dimensions for each material, the correspondence of commercial piping between materials is set out below.

The equivalence shall be made according to the internal diameter, which is what provides the flow and defines the nominal diameter (ND) in Central European countries, as opposed to the Spanish criterion of defining the ND by the external diameter, as indicated in the product standards. Remember that, beyond the following equivalence, the final selection is determined by the designer, but that in any event plastic piping, and especially PB, permits higher fluid velocities, so the interior diameters of the pipes are always smaller.

ND	Galvanised steel DIN2440/2448			CLASS 2 / 10 bar PB			CLASS 2 / 8 bar PP-R Series 2.5 (SDR 6)		PP-R CLASS 2 / 6 bar PEX CLASS 2 / 10 bar Series 3.2 (SDR 7.4)		CU (DIN1786) STAINLESS STEEL	
	Inches	De	Di	De	Di	SDR	De	Di	De	Di	De	Di
10	3/8"	17.2	12.5	15*	11.6	9	---	---	---	---	15	13.0
10	3/8"	17.2	12.5	16*	12.4	9	---	---	16	11.6	15	13.0
15	1/2"	21.3	16.0	20	15.4	9	25	16.6	20	14.4	18	16.0
20	3/4"	26.9	21.6	22	18	11	---	---	25	18.0	22	19.6
20	3/4"	26.9	21.6	25	20.4	11	32	21.2	---	---	---	---
25	1"	33.7	27.2	28**	23.0	11	---	---	---	---	28	25.6
25	1"	33.7	27.2	32	26.2	11	40	26.6	32	23.2	28	25.6
32	1 1/4"	42.4	35.9	40	32.6	11	50	33.4	40	29.0	35	32.0
40	1 1/2"	48.3	41.8	50	40.8	11	63	42.0	50	36.2	42	39.0
50	2	60.3	53.0	63	51.4	11	75	50.0	63	45.8	54	51.0
65	2 1/2"	76.1	68.8	75	61.4	11	90	60.0	75	54.4	76.1	72.0
80	3"	88.9	80.8	90	73.6	11	110	73.4	90	65.4	88.9	85.0
100	4"	114.3	105.3	110 ** (125)	90.0 (102.2)	11	125	83.4	110	79.8	108.0	103.0
125	5"	139.7	131.7	125 ** (160)	102.2 (130.8)	11	160	106.8	---	---	133.0	127.0
150	6"	168.3	159.3	160	130.8	11	---	---	---	---	159.0	153.0

* Considered 1/2" due to the greater flow rate permitted in PB

** Official conversion by the manufacturer

Note: Due to its low roughness, PB piping can transport fluid at higher velocities, therefore smaller diameters can be used to transport the same flow.

5. International standards for piping systems

5. INTERNATIONAL STANDARDS FOR PIPING SYSTEMS

5.1. International standards applicable to PB systems: UNE-EN ISO 15876

5.2. Field of application of PB systems

5.3. Classification of working conditions for PB systems

5.4. Calculation method for pipe dimensioning

5.5. Pipe marking

Nº 001/00234561 Nº 001/003001 Nº 002/004003 Nº 001/00234561
Nº 001/00234562 Nº 001/003002 Nº 002/004004 Nº 001/00234562
Nº 001/00234563 Nº 001/003003 Nº 002/004005 Nº 001/00234563

The famous Maastricht Treaty of 1992 and the reinvention of the European Union, at the same time as the disappearance of borders and national currencies, meant the elimination of local product standards through the creation of joint regulations that are applicable to all member states. Thus, when the peseta, the mark, the franc and other national currencies disappeared, the particular standards of each country ceased to exist. In the case of PB systems, UNE 53415 for Spain, BS 7291 for Great Britain, DIN 16969 for Germany and many other standards were repealed in favour of the new EN ISO 15876. The creation of this standard, in which Nueva Terrain participated as a speaker through Quality Director, Juan Carlos Casas, changed the way thermoplastic piping systems for hot and cold water supply and heating are identified and monitored, as we shall explain below. Even today people mistakenly refer to the old standards when planning PB systems. In this chapter, we will help you to recognise the main changes and definitions that the new standards entail.





5.1. International standards for PB systems: UNE-EN ISO 15876

A generic set of applicable standards has been drawn up for channelling systems in plastics for hot and cold water. A standard has been developed for each material (PB, PEX, PPR, PVC-C and PE-RT). Each standard is constituted by five parts:

- **Part 1:** general, where the working conditions are fundamentally defined for these systems, which are the same for all the materials.
- **Part 2:** pipes, where the calculation method (the same in all cases), the resulting dimensions and the physical characteristics of the pipes of each material are defined.
- **Part 3:** fittings, where the resulting dimensions and the physical characteristics of the fittings of each material are defined.
- **Part 5:** system, where the functional tests of the full system (pipes plus fittings) of each material are defined, including their connections.
- **Part 7:** certificate, methods and requirements for obtaining certification in each material.

5.2. Field of application of PB systems

The standard is applied to PB systems used in hot and cold water installations inside buildings (domestic systems) to transport water whether for human consumption or not, and under pressures and temperatures in accordance with the application class.

5.3. Classification of working conditions for PB systems

The standard defines four different kinds of service where each of them is a combination of temperatures and lifetimes (profiles of use) and not in the case of the previous Spanish standard that defined working pressures at each specific temperature.

Each class refers to a design lifetime of 50 years. This classification is unique and identical for all materials.

To understand this classification it is advisable to define some of the concepts used:

- **Working pressure (P_D):** working pressure for which the system has been designed.
- **Working temperature (T_{Op}):** temperature or combination of temperatures for the use of the water for which the system has been designed.
- **Maximum working temperature (T_{max}):** highest temperature that can be reached during operation but only during short periods of time.
- **Malfunction temperature (T_{mal}):** highest temperature that can be reached if the control limits are exceeded. (The time during which this situation may arise is limited to 100 hours during a period of 50 years.)
- **Cold water temperature (T_{cold}):** circulation temperature of cold water of approximately 20°C.

Classification of working conditions

CLASE DE APPLICABLE CLASS	TOP °C	TOP TIME YEARS	T Max °C	TIME T Max YEARS	T Mal °C	TIME T Mal HOURS	FIELD OF APPLICATION
1	60°	49	80°	1	95°	100	Hot water at 60°
2	70°	49	80°	1	95°	100	Hot water at 70°
4	20°	2.5	70°	2.5	100°	100	Underfloor heating and radiators at low temperatures
	40°	20					
	60°	25					
5	20°	14	90°	1	100°	100	Radiators at high temperatures
	60°	25					
	80°	10					

1) Each country can choose class 1 or class 2 according to their national regulations.

Requirements:

- Each class can be combined with working pressures of 4, 6, 8 or 10 bar. Therefore and unlike the old Spanish standard the working pressures are already preset for all materials. It is understood that given an installation, for example sanitary hot water, the working conditions of its design are independent of the material of the pipes and these pipes have to fulfil these conditions.
- All systems that satisfy one these categories should also be useful for the cold water supply for 50 years with a working pressure of 10 bar.
- Class 4 consists of 2.5 years at 20°C, plus 20 years at 40°C, plus 25 years at 60°C.
- Class 5 consists of 14 years at 20°C, plus 25 years at 60°C, plus 10 years at 80°C.

5.4. Calculation method for pipe dimensioning

The regression curves for each material have their own mathematical equations that are those that are really used in the calculation, instead of those in the graphs.

Using these equations, taking into account the specifications of each class, applying Miner's rule (see Annex 3) and using the working coefficients (called safety factors in the old Spanish standard) of each material, we obtain the stress design for each class σ_d (called the calculation stress in the Spanish standard).

The working coefficients for the case of PB are:

Working coefficients

TEMPERATURE	WORKING COEFFICIENTS
T _{OP}	1.50
T _{max}	1.30
T _{mal}	1.00
T _{cold}	1.25



The stress designs obtained from for PB pipes are
(see Annex 4 for an example of the specific application of the calculation for class 2):

Stress design

CLASS	STRESS DESIGN (MPa)
1	5.73 (σ_D)
2	5.04 (σ_D)
4	5.46 (σ_D)
5	4.31 (σ_D)
20°C - 50 years	10.92 (σ_D)

For a given class with a given working pressure it is necessary to determine the maximum value of S_{max} that the series S to which the pipe belongs can have, with the purpose of determining the thicknesses of each diameter.

Because the pipe must withstand the conditions of lifetime and temperature of its class, and must also be valid for work at 10 bar for 50 years at 20°C, the S_{max} value will be the smallest of the following two:

$$\frac{\sigma_D}{P_D} \quad \frac{\sigma_{Dcold}}{10}$$

With these constraints the following S_{max} values are obtained for PB pipes:

S_{max} values for PB pipes

CLASS	PD 4 bar	PD 6 bar	PD 8 bar	PD 10 bar
1	10.9	9.5	7.1	5.7
2	10.9	8.4	6.3	5.0
4	10.9	9.1	6.8	5.4
5	10.9	7.2	5.4	4.3

Thicknesses of the PB pipe wall for different series

Nominal \varnothing ND/OD	Exterior medium \varnothing		Series					
			S 10	S 8	S 6.3	S 5	S 4	S 3.2
	Ext. min. \varnothing	Ext. min. \varnothing	Wall thickness					
12	11.9	12.2	1.3	1.3	1.3	1.3	1.3	1.6
15	14.9	15.2	1.3	1.3	1.3	1.3	1.7	2.0
18	17.9	18.2	1.3	1.3	1.3	1.6	2.0	2.4
22	21.9	22.2	1.3	1.3	1.6	2.0	2.4	3.0
28	27.9	28.2	1.3	1.6	2.0	2.5	3.1	3.8
35	34.9	35.4	1.3	2.0	2.6	3.2	3.9	4.8

Thicknesses of the PB pipe wall for different series

Nominal \varnothing ND/OD	Exterior medium \varnothing		Series					
			S 10	S 8	S 6.3	S 5	S 4	S 3.2
	Ext. min. \varnothing	Ext. min. \varnothing	Wall thickness					
12	12.0	12.3	1.3	1.3	1.3	1.3	1.4	1.7
16	16.0	16.3	1.3	1.3	1.3	1.5	1.8	2.2
20	20.0	20.3	1.3	1.3	1.5	1.9	2.3	2.8
25	25.0	25.3	1.3	1.5	1.9	2.3	2.8	3.5
32	32.0	32.3	1.6	1.9	2.4	2.9	3.6	4.4
40	40.0	40.4	1.9	2.4	3.0	3.7	4.5	5.5
50	50.0	50.5	2.4	3.0	3.7	4.6	5.6	6.9
63	63.0	63.6	3.0	3.8	4.7	5.8	7.1	8.6
75	75.0	75.7	3.6	4.5	5.6	6.8	8.4	10.3
90	90.0	90.9	4.3	5.4	6.7	8.2	10.1	12.3
110	110.0	111.0	5.3	6.6	8.1	10.0	12.3	15.1

Examples of use of these results:

- 1- If we take a pipe with an exterior diameter of 20 mm that must be used for class 5 with a pressure of 10 bar. The maximum S value permitted is 4.3. It is necessary to select the highest standardised S value lower than 4.3. In this case, this value is 4 and therefore the pipe will be 20 x 2.3, in other words series 4, SDR 9.
- 2- If we take a pipe with an exterior diameter of 40 mm that must be used for class 4 with a pressure of 6 bar. The maximum S value permitted is 9.1. It is necessary to select the highest standardised S value lower than 9.1. In this case, this value is 8 and therefore the pipe will be 40 x 2.4, in other words series 8, SDR 17.
- 3- If we take a pipe with an exterior diameter of 25 mm that must be used for class 2 with a pressure of 10 bar. The maximum S value permitted is 5. It is necessary to select the highest standardised S value lower than 5. In this case, this value is 5 and therefore the pipe will be 25 x 2.3, in other words series 5, SDR 11.

Applying the same method to the equations of other materials, with their specific working coefficients, their own S_{max} values (maximum pipe series) are obtained:

S_{max} Values for different plastic materials

CLASS 1						CLASS 2					
Pop	PB	PEX	PPR	PVCC	PERT	Pop	PB	PEX	PPR	PVCC	PERT
4	10.9	7.6	6.9	10.0	6.7	4	10.9	7.6	5.3	10.0	6.7
6	9.5	6.4	5.2	7.3	5.5	6	8.4	6.4	3.6	6.9	4.5
8	7.1	4.8	3.9	5.5	4.1	8	6.3	4.8	2.7	5.2	3.4
10	5.7	3.8	3.1	4.4	3.3	10	5.0	3.8	2.1	4.2	2.7

CLASS 4						CLASS 5					
Pop	PB	PEX	PPR	PVCC	PERT	Pop	PB	PEX	PPR	PVCC	PERT
4	10.9	7.6	6.9		6.7	4	10.9	7.6	4.8		6.0
6	9.1	6.6	5.5		5.4	6	7.2	5.4	3.2		4.0
8	6.8	5.5	4.1		4.1	8	5.4	4.0	2.4		3.0
10	5.4	4.0	3.3		3.3	10	4.3	3.2	1.9		2.4

* For PVC-C, classes 4 and 5 are not applicable and this material cannot be used for these services.



Using the previous values and the standardised S values in each of the documents for each material, the following tables indicate, for example, the necessary thickness values for a pipe with an external diameter of 25.

Thickness necessary according to the standards for a Ø25 mm, depending on the material used and the pressure at which we wish to work:

CLASS 1						CLASS 2					
Pop	PB	PEX	PPR	PVCC	PERT	Pop	PB	PEX	PPR	PVCC	PERT
4	1.3	1.9	2.3	1.9	2.3	4	1.3	1.9	2.3	1.9	2.3
6	1.5	1.9	2.3	1.9	2.3	6	1.5	2.3	3.5	1.9	2.8
8	1.9	2.8	3.5	2.3	2.8	8	1.9	2.8	4.2	2.3	3.5
10	2.3	3.5	4.2	2.8	3.5	10	2.3	3.5	5.1	2.8	4.2

CLASS 4						CLASS 5					
Pop	PB	PEX	PPR	PVCC	PERT	Pop	PB	PEX	PPR	PVCC	PERT
4	1.3	1.9	2.3		2.3	4	1.3	1.9	3.5		2.3
6	1.5	1.9	2.3		2.3	6	1.5	2.3	3.5		2.8
8	1.9	2.3	3.5		2.8	8	2.3	2.8	5.1		3.5
10	2.3	2.8	3.5		3.5	10	2.8	3.5			

* For PVC-C, classes 4 and 5 are not applicable and this material cannot be used for these services.

The empty cells indicate that in the standard corresponding to the material there is no standardised series that satisfies the requirement of being lower than the maximum series permitted. Therefore there is no pipe with an outer diameter of 25 mm that fulfils this application.

As can be verified, for the same external diameter and for the same application, the thickness required by the European standard for a PB pipe is lower than that required of a pipe in any other material. This is due to the excellent characteristics of PB in terms of pressure resistance.

For example, we can consider a hot water installation at 70°C, in other words a class 2 application, that will work at 10 bar. If the material selected is PB, a thickness of 2.3 mm would be necessary, if the material were PP R the thickness would be 5.1 mm, if it were PEX it must be 3.5 mm, if it were PERT it would be 4.2 and finally if it were PVC-C the thickness must be 2.8 mm.

Comparison of the material thickness

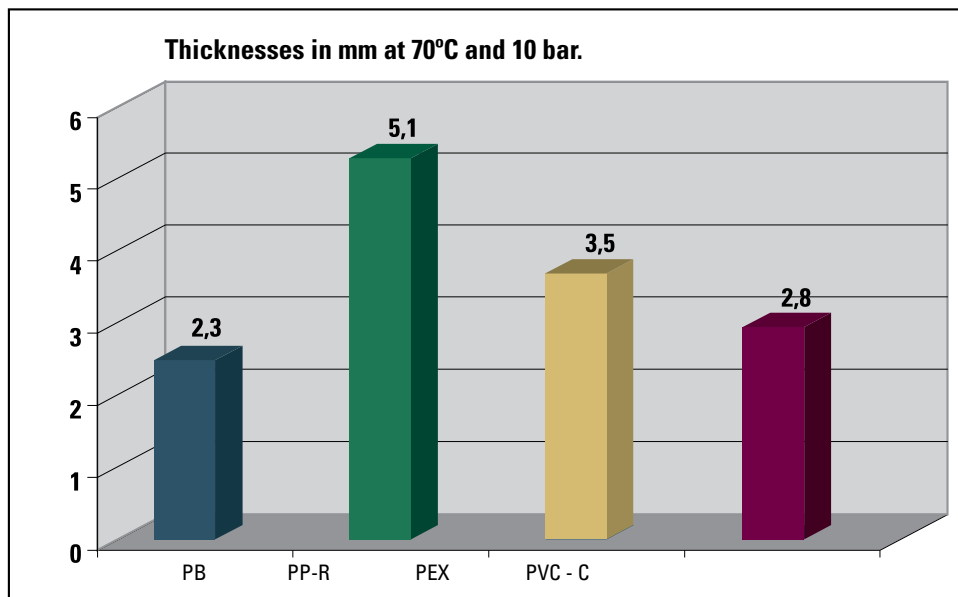

These differences mean that the internal diameter through which the flow passes is 27% lower in PP r than in PB; 12% lower in PEX than in PB, 18% lower in PERT than in PB and 5% lower in PVC-C.

These differences mean that if the pipe selected is PB, its weight will be lower than that of the other options, for the same supply flow necessary the velocity of the water will be lower as a result, the head loss will be lower. For example:

	PB 25 x 2.3	PERT 25 x 4.2	PPR 25 x 5.1	PEX 25 x 3.5	PVC-C 25 x 2.8	UNITS
Weight every 10 m.	1.50	2.60	2.90	2.20	3.00	kg
Velocity for 0.1 l/s	0.31	0.46	0.58	0.39	0.34	m/s
Velocity for 0.5 l/s	1.53	2.31	2.91	1.96	1.69	m/s
Pressure drop for 0.1 l/s	0.90	2.20	4.00	1.60	1.10	mbar/m
Pressure drop for 0.5 l/s	14.40	37.00	67.00	26.20	18.90	mbar/m

With regard to the above, as an example for comparison, Annex 2 provides the regression curves of PB, PEX, PP-R and PERT, for a temperature of 80°C.

In the old Spanish standard the concept of nominal pressure (NP) was used as the working pressure at 20°C and values, for example, of 16 bar and 20 bar were used. Nevertheless in the current standard this concept is no longer used and the working pressures used for all of the materials are 4, 6, 8 and 10 bar, as they refer to hot water.

Does this mean that since the standard changed, PB pipes no longer withstand pressures greater than 10 bar at 20°C?

Evidently the answer is no. For a lifetime of 50 years at a temperature of 20°C, the pipes still have a maximum working pressure greater than 10 bar. What does change is not the resistance of material but rather the philosophy and the concepts of the standard and therefore any other interpretation is erroneous.



The maximum operating pressure at a given temperature and lifetime is calculated by directly applying the formula:

$$P_{\max} = \frac{\sigma}{S \times C}$$

Where: **P** is the maximum operating pressure in the conditions defined.

σ is the hydrostatic stress for the conditions defined, obtained from the regression curve or by calculating the equations of this curve.

S is the series to which the pipe belongs.

C is the working coefficient (safety factor) at the temperature defined.

If these calculations are performed for the temperature 20°C the following results are obtained:

Maximum working pressure (bar)

T	C	t (years)	σ (MPa)	S-10 (bar)	S-8 (bar)	S-6.3 (bar)	S-5 (bar)	S-4 (bar)	S-3.15 (bar)
20°C	1.25	1	14.51	11.6	14.5	18.4	23.2	29.0	36.9
20°C	1.25	5	14.34	11.5	14.3	18.2	22.9	28.7	36.4
20°C	1.25	10	14.24	11.4	14.2	18.1	22.8	28.5	36.2
20°C	1.25	25	13.91	11.1	13.9	17.7	22.2	27.5	35.3
20°C	1.25	50	13.66	10.9	13.7	17.3	21.9	27.3	34.7

Therefore a pipe of for example Ø25x2.3, that belongs to series 5, has a maximum working pressure at 20°C and 50 years of 21.9 bar; a pipe of for example Ø16x1.8, that belongs to series 4, has a maximum working pressure at 20°C and 50 years of 27.3 bar.

Evidently, these same calculations can be made for other temperatures and lifetimes.

5.5. Pipe marking

All the piping on the market is marked with text that is not generally given the importance it really should: this marking defines all of the characteristics of the pipe. The regulations require minimum information as well as some general requirements regarding the quality of the marking. The standard UNE EN ISO 15876 is no exception and the PB piping by Nueva Terrain more than meets the requirements.

GENERAL REQUIREMENTS

- The marking is printed directly on the pipe at least once per metre, in such a way that after the storage, handling and installation it remains legible.
- The colour of the ink used clearly differs from the colour of the pipe, thus guaranteeing its readability.
- The size of the marking is big enough to be legible without magnification.
- The marking is made with no mechanism making physical contact with the pipe and therefore there is no damage to the surface so the beginnings of fissures or any other type of defect are not caused.

Minimum marking required on the pipe

This specific example shows the meaning of the whole marking:

TERRAIN SDP PB 22X2.0 – DIMENSION B1 – CLASS 2 / P10 BAR Opaque UNE-EN ISO 15876
AENOR – N – 001/168 Day, Time and Line 20°C – 21.9 bar KIWA 10 bar CERTIF MADE IN SPAIN

- 1.- TERRAIN SDP:** this is our brand name and identifies us as the manufacturer.
- 2.- PB:** material from which the pipe is manufactured, in this case polybutylene.
- 3.- 22 x 2.0:** nominal dimensions. External diameter 22 mm and thickness 2.0 mm
- 4.- Dimension B1:** The standard establishes different classes or types of dimensions: A for the metrics and B1 and B2 for the dimensions based on copper piping. In this example the diameter 22 belongs to the dimension class B1.
- 5.- 2 / 10 bar.** Maximum class for application and working pressure for which the pipe has been designed. Only the highest class is printed as it is understood that the remaining categories are included. In this case it is suitable for Class 2 and a pressure of 10 bar, in addition to Class 1, 10 bar; Class 4 / 10 bar; 5 / 8 bar.
- 6.- Opaque.** The pipe is defined as opaque because it does not transmit more than 0.20% of the visible light when tested according to the standard UNE-EN ISO 7686. This characteristic implies that microorganisms and algae that need light to proliferate will not grow inside the pipe, thus guaranteeing its safety with regard to health.
- 7.- UNE-EN ISO 15876** Standard according to which the pipe has been manufactured and therefore all the characteristics required by it have been completely fulfilled.
- 8.- AENOR – N – 001/168.** Full compliance with the standard is guaranteed by AENOR and this means we can print the N as a quality marking. The number is none other than the contract signed between AENOR and Nueva Terrain and that regulates the certification.
- 9.-** With the purpose of guaranteeing full traceability the PB pipes by Nueva Terrain **have the date, the hour and the minute** at which they were manufactured printed on them, as well as the manufacture shift and the extrusion line on which they were produced.
- 10.- 20°C – 21.9 bar.** The maximum working pressure for 50 years and 20°C, in this case, 21.9 bar is also included.
- 11.- Keys for other international certifications,** if applicable. This is the case for the Dutch KIWA, that only considers Class 2 (Domestic hot water at 70°C) and is therefore already implied in the marking.
- 12.- MADE in SPAIN.** The place of manufacture is specified.



6. PB-1 SYSTEMS AND SUSTAINABLE CONSTRUCTION

6.1. Comparative environmental impact study

6.2. Standardisation and legislation. Future trends

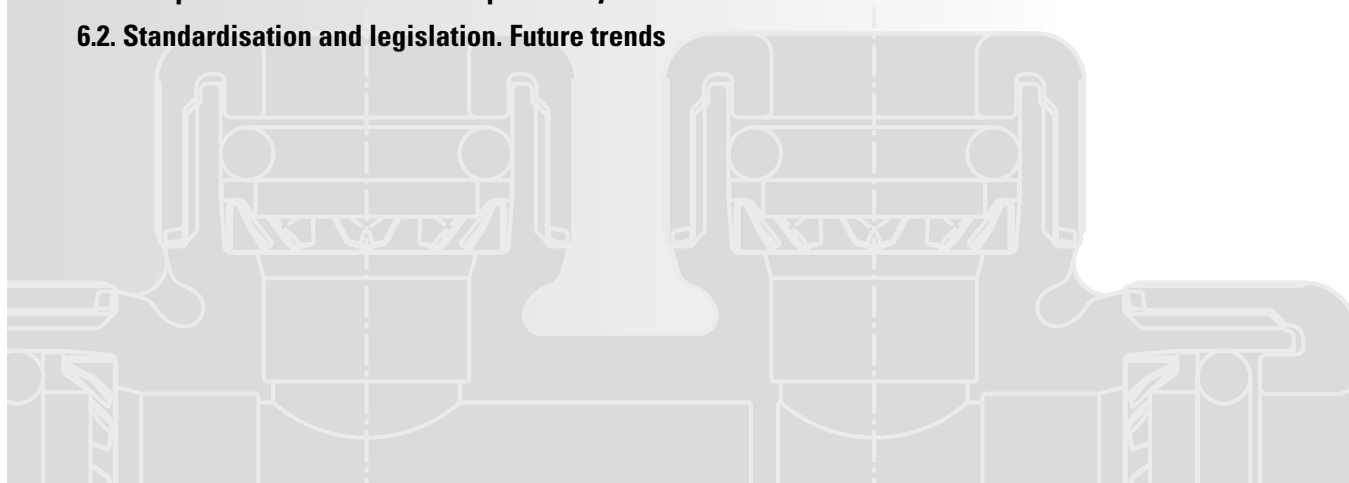

The need for the market to move toward sustainable construction will become a reality regardless of the political motivations and short-term economic prospects. The future shortage of resources, the legitimate access to new population commodities that up to now are underdeveloped, and the progressive awareness of the different parties involved in the market (via legislation, via the economy or via the market) will make it obligatory to select the most appropriate materials for the construction. In this scenario, it is evident that the materials that are optimum for the application, consume fewer resources for their manufacture and have the possibility of recycling will be the most recommendable products.

Thus, at the TU Berlin they have developed their own independent procedure for evaluating the environmental impact of drinking water supply installations. They created an analytical method, defined as VENOB, which is an objective and equivalent study of the energy consumption of each installation, from the process of obtaining the raw material to the installation of the final product. The results, that are set out below, demonstrated that PB is the material that in terms of energy efficiency and waste generation, is the least harmful to the environment among all competing products.



6.1. Comparative environmental impact study

To be able to make an objective comparison of the environmental impact of the piping systems, it is necessary to use an evaluation method that compares products of a different nature but that are intended for the same application.

The plastics technology department of the TU Berlin directed an environmental analysis study of drinking water installations by developing their own comparison method, called VENOB.

With this method they performed an analysis, based on scientific facts, that compared the total consumption of energy and the possible emissions into the air, water and ground, taking into account all stages from the production of the raw material to the installation of the piping final systems, including the manufacture of the pipes and fittings.

For the study they took a building of 16 dwellings with a central hot water system and a supply pressure of 4 bar. Six different situations were considered, where in each of them the drinking water installation of that building was made in the following materials: copper, galvanised steel, PE-X, PP-R, PB and PVC-C.

Firstly they analysed the energy necessary for the production of 1,000 kg of piping and fittings in the six materials. The results obtained can be compared in the following graph:

Energy consumption for the production of 1,000 kg of piping and fittings

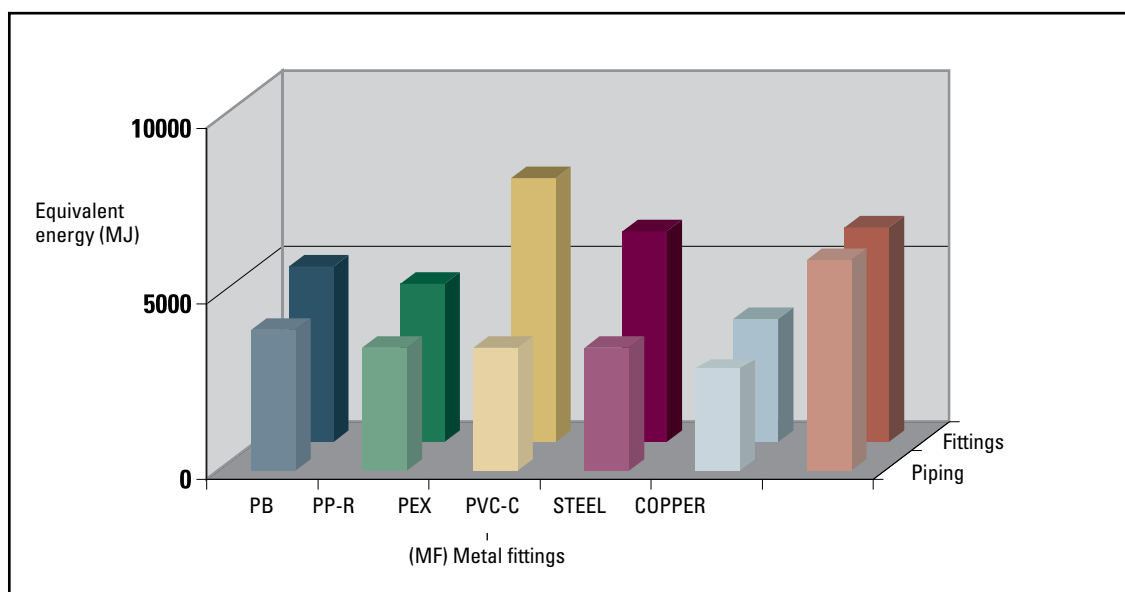

It is clear that the previous graph does not provide enough information to be able to compare the different materials; plastics weigh much less than metals so with 1000 kg of piping or fittings many more metres of the installation can be made.

Moreover the weight of the full system of pipes and fittings used was compared for each of the six materials indicated, necessary for the installation of the aforementioned building.

It is important to note that, as in section 3.7, due to their high mechanical performance, the same installation in PB needs smaller dimensions than pipes made with other materials.



Comparison of the weight of the plumbing installation

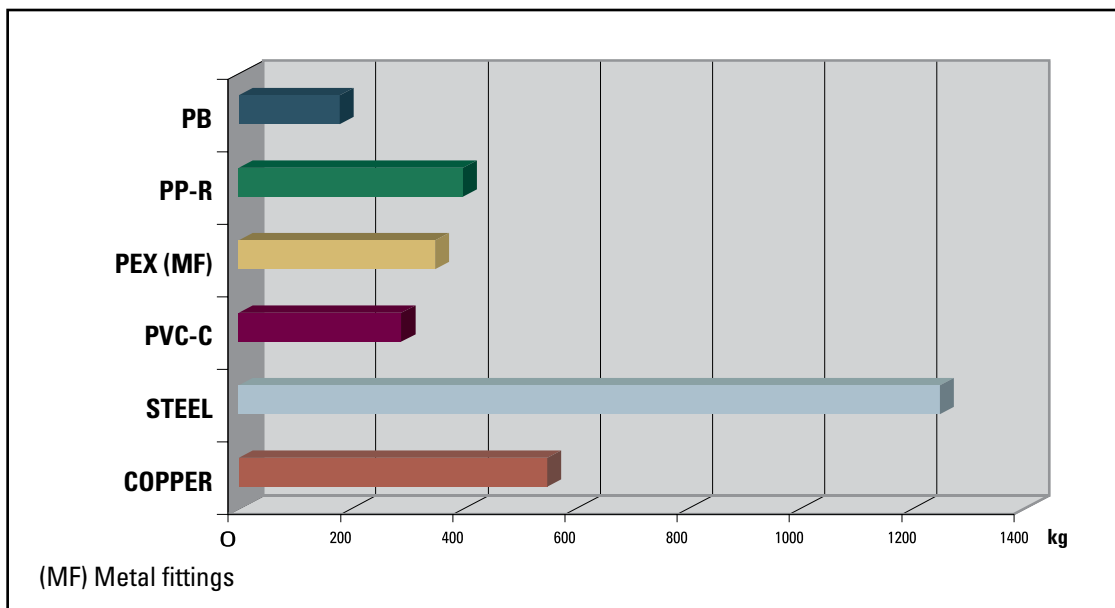

Using the previous data they obtained the equivalent energy of the complete piping system for each material. This data is shown comparatively in the following graph.

Comparison of equivalent energy consumed to complete an installation:

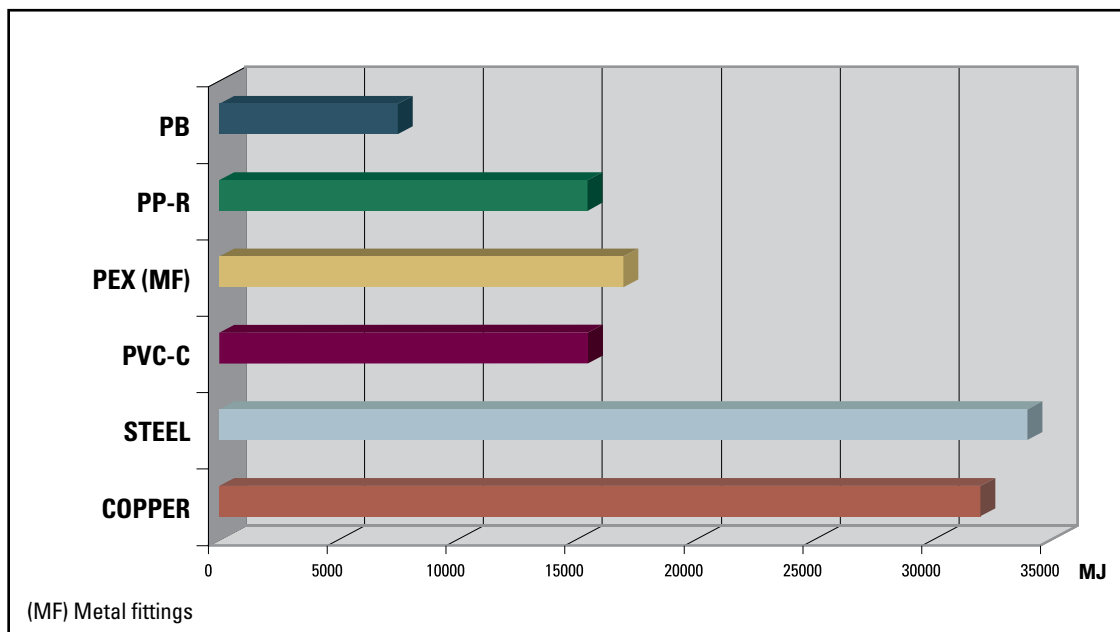

As can be verified, the same installation has a lower energy consumption when made with PB polybutylene system. As we have already indicated, in the study by the TU Berlin they also compared emissions possible into the air, water and ground for each of the six materials.

The data obtained appears in the following graphs:

Comparison of the impact on the environment due to emissions into the ground

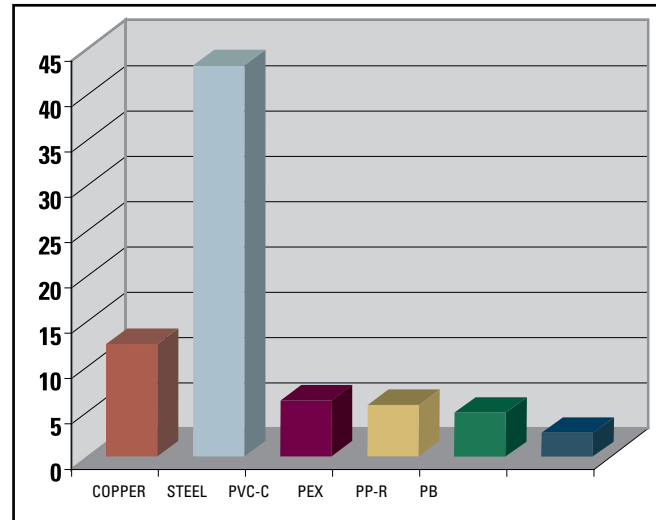

Factor without dimensions

Comparison of the impact on the environment due to emissions into water

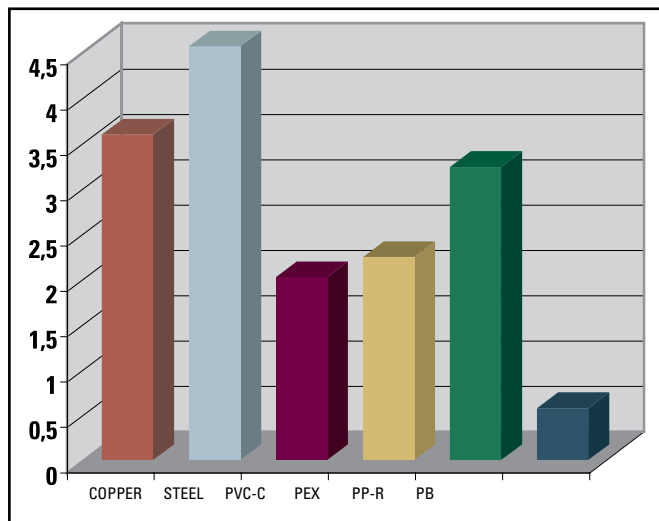

Factor without dimensions

Comparison of the impact on the environment due to emissions into the air

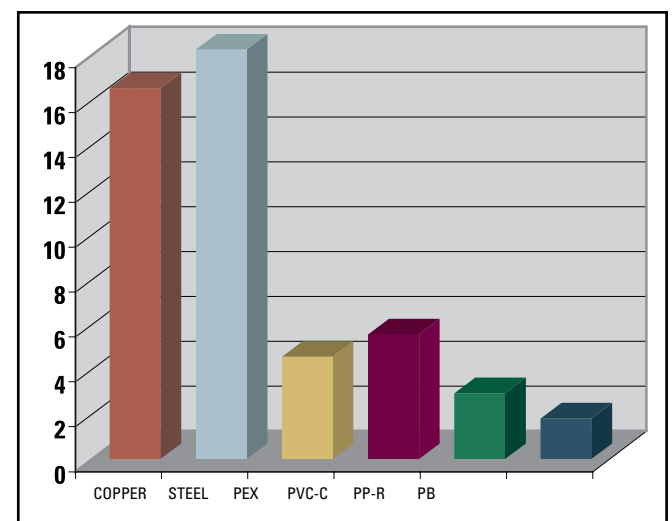

Factor without dimensions

6.2. Standardisation and legislation. Future trends

The subject of sustainable construction is one of various contemporary debates in forums in the standardisation sector. The efforts of the different international (ISO/TC 59/SC14), European (CEN/TC 350) and national (AEN/CTN 198) work groups in the preparation of standards that qualify construction in both civil works and buildings really is of the moment. The objective is to create a framework of standards that objectively and independently assess the sustainability of both buildings and the construction products that constitute them.

Our interest as manufacturers of piping systems principally lies in the standards that identify the latter. Concepts such as the carbon footprint of the product, its LCA (life cycle assessment of the product) or EPD (environmental product declaration) are what identifies the "aggression" against the environment of each product. The task is to create standardised methods that obtain results and objectives in such a way that comparisons can be made between products.



7. JOINT SYSTEMS

7.1. Push-fit joint

7.2. Socket fusion joint

7.3. Electrofusion joint

7.4. Butt fusion joint

7.5. Flanged joint

7.6. Transition joints

7.7. Leak testing in the installations

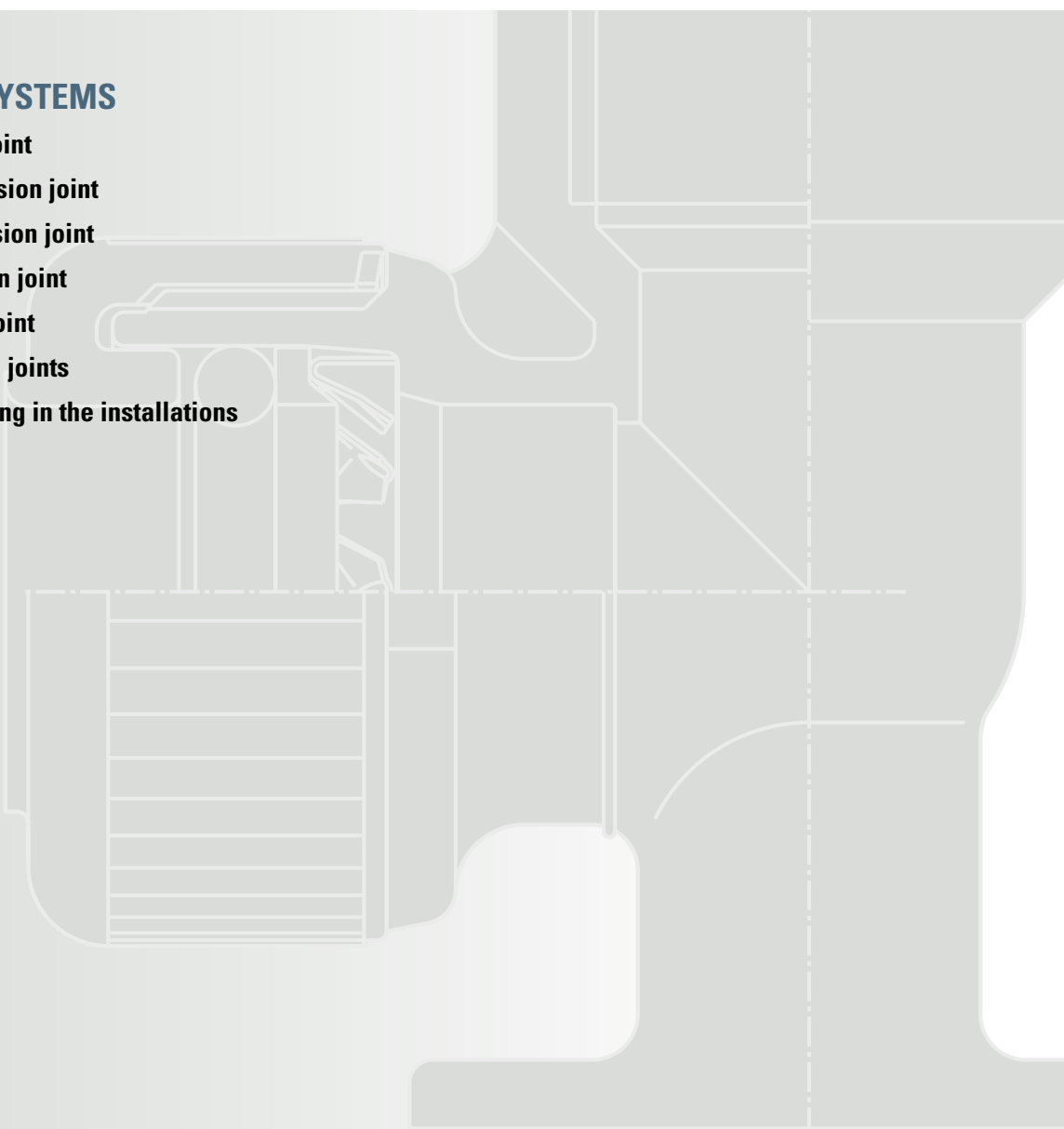

7. Joint systems

The advantages set out up to now of PB as a material have mainly concentrated on the excellent characteristics of the piping and fittings of the installation. It is clear that the joints between the components of the system have an essential significance. This is why, beyond the explanations and subsequent recommendations, Nueva Terrain requires their own pipes and fittings to be used in order to guarantee the installations. Combining components, not only in our system, can cause the installation to fail regardless of the individual quality of each of them. PB as a material has optimum characteristics for connection using the most versatile and varied systems: mechanical joints and fusion or thermal welding. Thus, Nueva Terrain offers four different joint systems depending on the needs of the installation and the skill and/or requirements of the installer.

+ Push-fit joint: A unique system of mechanical joints that is quick, easy and reliable. Connection using grab rings, not compression. Tools are not necessary and it is the quickest on the market. Of particular interest for installations with small diameters and a large number of joints.



+ Socket fusion joint: It is a fusion joining method, heating the pipe and fitting in furnaces. Reliable installations that are more economical in terms of materials and with a lower volume, but that take longer to install. Recommended in installations of medium diameters with few connections, and in workshop-based joints or in optimum conditions of installation.



+ Electrofusion joint: It is a fusion joining method, heating the pipe and fitting using an electrical resistance at the mouth of the fitting. Cold assembly of pipe and fitting, which enables simple installation even in the most difficult conditions and positions. Recommended for larger diameters and installations on construction sites.



+ Butt fusion joint: It is a fusion joining method. Reliable installations that are more economical with a lower volume, but are more complex to carry out on construction sites. Recommended for larger diameters and installations in the workshop.



The joint systems aforementioned, as well as the range of diameters and variety of fittings, result in a complete catalogue that provides solutions to the most varied of installations with the best materials and systems available.



The range and systems of joints provided by Nueva Terrain are set out below:

Ø mm	15	16	20	22	25	28	32	40	50	63	75	90	110	125	160
Push-Fit	√	√	√	√	√	√	√	√	√						
Socket fusion		√	√		√		√	√	√	√					
Electrofusion											√	√	√	√	√
Butt fusion											√	√	√	√	√

*Type of joint according to diameter.

7.1. Push-fit joint

Also defined internally as the Classic joint system, as it was with this original system that the company launched its catalogue of the company in the 1980s. It can make quick connections up to diameters of 50 mm, a milestone in grab ring joint systems.

This system, characteristic of Terrain, adds the following to the advantages of PB as a raw material:

- Ease and speed of fitting, with the economic savings that this entails.
- The joint is not rigid and the joints can be rotated, even under load, which means it is not necessary to calculate or contemplate the different directions and angles in the direction changes.
- Special tools are not needed to make the joints, apart from the pipe cutter.
- Unlike other mechanical joints, the pipe is not compressed from either the interior or exterior.
- The pipe does not need any type of tool or fitting to adopt shapes or measurements different from its original form, therefore the creep resistance typical of plastic materials, in other words, the elongation of the material in function of time under constant load, does not influence the grab ring joints.
- The Terrain push-fit system, unlike other press-fitting, sliding sleeve or push-fit systems that are sealed on the internal diameter, the internal diameter of the fittings is not reduced. This implies exceptional or localised losses in the fitting that are far lower, which results in a lower pressure drop in the installation and optimum flow at the point of consumption.

The reliability of the joint is confirmed by numerous tests performed on the joint system, performed in laboratories of both Terrain and other independent organisations, as well as various certifications. The system has been on the market since 1982, with more than 250 million joints installed in construction works.

Tools necessary for installation:

The Push-Fit system is characterised by the fact that specific installation tools are not needed, it is sufficient to fit the pipe into the fitting by hand. Nevertheless we recommend using pipe cutters to cut the piping, silicone to lubricate it and a marker pen to mark the penetration length.

Personnel able to make the joint:

In reality, no special qualifications are needed to make the joints themselves, although it is important for the person performing any plumbing or heating installation to have some basic knowledge to ensure the system functions well.

Steps to follow for assembly:

1 Cut the pipe



2 Insert the supporting sleeve



3 Lubricate.

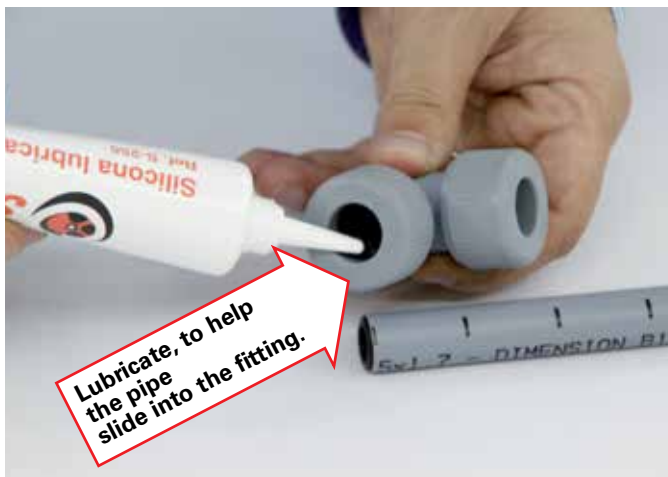

4 Insert the pipe.

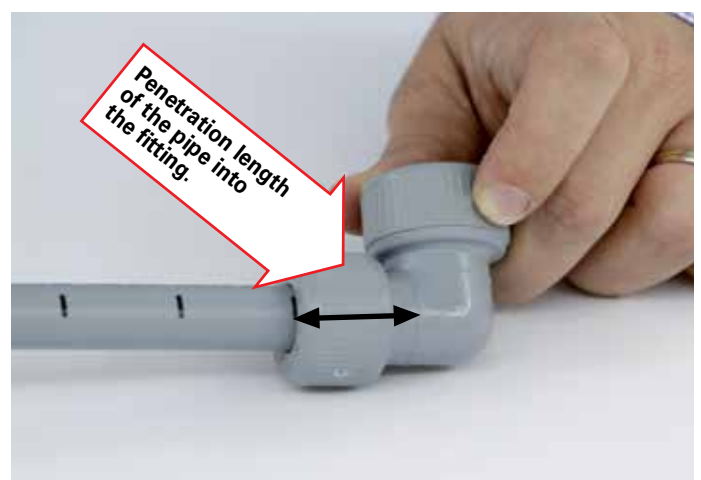

Note: You must ensure that the pipe has been inserted into the fitting up to the mark made with the marker pen or, failing that, up to the next mark on the pipe.

5 Wrong



6 Right





Joint parameters:

Penetration length of the pipe in the Push-Fit system

External D of pipe (mm)	Pipe penetration length (mm)
15	25
16	25
20	27
22	27
25	27
28	30
32	32
40	43
50	43

Recommendations to ensure a good joint:

- Do not use pipes with an external surface that has been damaged with scratches, deep marks, chips, etc...
- The fittings are supplied assembled and may not be manipulated; they must be used exactly as they are supplied. This avoids possible errors in adjustments and tightening. It is harmful to force the fitting by trying to unscrew the nut.
- Respect the lengths of penetration, either by using a marker pen to mark the pipe or using the marks made in the factory.
- Once the pipe has been inserted into the fitting, never manipulate the grab rings, in other words, do not modify their original placement, remove them from the pipe or reuse them.
- Never reuse a grab ring. If a joint is dismantled, the grab ring must be replaced with a new one, even though it may not look damaged.

VERY IMPORTANT: it is essential that the pipe is inserted up to the mark on the pipe, or up to the mark made with the marker pen, to ensure proper installation.

Possible assembly errors and their consequences:

ASSEMBLY ERROR	CONSEQUENCE
Use of piping with the surface in poor condition (scratches, marks, chips, etc.)	The joint might not be capable of absorbing the superficial defects and leaks will occur.
Insufficient penetration depth (incomplete insertion of the piping)	With the increase in pressure the pipe may come out of the fitting.
Reuse of the grab ring.	A reused grab ring will not grip the pipe properly and can cause the pipe to come out of the fitting.
Pipe cut not perpendicular	An extremely oblique cut can cause the grab ring to fail to grip the pipe uniformly, causing the pipe to come out.
Cuts with burrs	The burrs from the cut can get in between the gasket and the pipe cause leakage.
Handling fittings (threaded nut)	A fitting with a poor thread can cause leakage or the pipe to come out.
Dirt in the fitting or pipe	The dirt can get in between the gasket and the pipe cause leakage.

7.2. Socket fusion joint

Socket fusion between the exterior surface of the pipe and the interior of the fitting.

The proper functioning of the joint depends on the good condition of the tools used, the cleanliness of all of the elements, the experience of the installer in welding polybutylene and the correct monitoring of the joint parameters defined.

Tools necessary for installation

- Commercial socket fusion machine with a furnace temperature of 260°C
- Weld furnaces
- Pipe cutter and bevelling machine
- Chronometer or clock
- Marker pen
- Alcohol for cleaning
- Paper for cleaning (use kitchen roll)

Personnel able to make the joint:

The joints must be made by staff trained in socket fusion techniques for plastic materials, with sufficient experience with PB joints.

Instructions for assembly:

- 1 The pipe and the fitting to be welded must be of same diameter and material.
- 2 Cut the pipe perpendicular to its length, ensuring that the cut is as uniform as possible.
- 3 To ensure the pipe penetrates the mouth of the fitting easily the exterior edge of the pipe can be bevelled.
 - Pipes with diameters of 16 and 20 mm do not need bevelling.
 - For pipes with diameters of 25, 32 and 40 mm bevelling is recommended.
 - Pipes with diameters of 50 and 63 mm must be bevelled.
- 4 Clean the surfaces to weld, both pipe and fitting, using absorbent, lint-free paper, dampened with an ethyl alcohol based detergent that is free from oils and greases.
- 5 Clean the polyfusor furnaces using the same technique as for the pipe and fitting. Cleaning is easier if they have been heated slightly beforehand.



- 6 Mark the penetration length necessary according to the diameter on the pipe. This is a very simple way to ensure you have inserted the pipe far enough into the fitting once you have made the joint (see table of joint parameters).

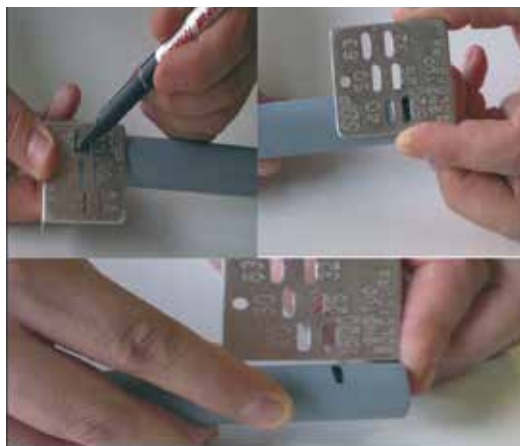

- 7 The temperature of the furnaces must be set to 260°C; check this before starting to make the joint.
- 8 Insert the pipe and the fitting simultaneously into the furnaces and leave them there during the heating time (see table of joint parameters). Exert a light pressure against the furnaces during the process.



- 9 At the end of the heating time, remove the pipe and fitting from the furnaces and insert the pipe into the mouth of the fitting to form the joint. Apply a light axial pressure during the maintenance time (see table of joint parameters) to prevent the pipe moving.



- 10 Once the joint is finished, wait for the cooling time (see table of parameters) before handling the joint to continue with the installation.
- 11 After 1 hour after the last weld, the installation will be ready for commissioning at its working pressure.
- 12 Wait at least 24 hours before performing the pressure test explained in section 7.7.

Joint parameters

TABLE 1 Parameters for socket fusion PB.

PIPE DIAMETER (mm) ND	WALL THICKNESS OF PIPE E (mm.)	LENGTH OF WELD L (mm)	TIME OF HEATING (Seconds)	TIME OF MAINTENANCE (Seconds)	TIME OF COOLING (Seconds)
16	2.2	15	5	15	2
20	2.3	15	6	15	2
25	2.3	18	6	15	2
32	2.9	20	10	20	4
40	3.7	22	14	20	4
50	4.6	25	18	30	4
63	5.8	28	22	30	6

Recommendations to ensure a good joint:

- Observe the parameters indicated for each diameter (penetration depth, heating time, maintenance time and cooling time).
- Check that the temperature of the furnaces is correct (260°C).
- Check the penetration length once the joint is finished using the mark made beforehand.
- If the welding is to be done outdoors, try to work in an area that is shielded from wind and rain, as this can affect the temperature reached by the material.
- Do not rotate the pipe or fitting when inserting them in the furnaces or when making the joint.

Possible assembly errors and their consequences:

ASSEMBLY ERROR	CONSEQUENCE
Insufficient penetration length	The contact surface between the pipe and the fitting is smaller, and can cause the pipe to come out.
Low furnace temperature. < 260°C	The PB does not melt correctly and the joint is not correct. The pipe may drip or even come out.
High furnace temperature. > 260°C	The PB is degraded due to the excessive temperature and the joint is not correct. The pipe may drip or even come out.
Dirt in the furnaces, pipes or fittings.	Remains of grease and dirt do not allow the surfaces of the pipe and fitting to fuse correctly. Joint not correct. The pipe may drip or even come out.
Cut not perpendicular	Asymmetrical fusion of pipe and fitting. Possible leakage.
Piping without bevel	Melted material is dragged as the pipe is inserted into the fitting. Difficulty inserting the pipe. The pipe may drip or even come out.
Insufficient welding time	The PB does not melt correctly and the joint is not correct. The pipe may drip or even come out.
Fusion time too long	The PB is degraded due to the excessive heat and the joint is not correct. The pipe may drip or even come out.
Insufficient maintenance time	The pipe may move out of its position inside the fitting. The pipe may come out.



7.3. Electrofusion joint

The only universal joint welded at 40 V on the market for PB pipes and fittings. A safe and easy connection, even in the most complex cases, as the joint is made cold. Ensure the fittings and the length of pipe that will penetrate the fitting are clean, and the joint will be done by the machine.

Tools necessary for installation

- Commercial electrofusion machine with a 40 V output (direct current)
- Pipe cutter
- Marker pen
- Alcohol for cleaning
- Reamer (recommended)
- Paper for cleaning (use kitchen roll)

Personnel able to make the joint

The joints must be made by staff trained in electrofusion techniques and with practical knowledge in the use of the welding machine used.

Instructions for assembly:

- 1 Cut the pipe perpendicular to its axis leaving the section as uniform as possible.



- 2 Ream and clean the pipe and the area inside the sleeve using lint-free absorbent paper soaked in alcohol for cleaning. Once the surfaces are clean, take care not to leave them on soiled surfaces or handle them with dirty hands.



- 3 Use the marks on the sleeve to mark penetration length on the pipe.



- 4 Insert the pipe up to the mark made.



- 5 Connect the electrical terminals of the electro-welding machine to the sleeve.



- 6 Using the reader pen, read the barcode on the sleeve.



- 7 Accept the parameters read and begin the welding process.



- 8 During the fusion process, keep at least a metre away from the fusion area and do not handle the installation.
- 9 Once the fusion is finished, wait for the cooling time indicated in the table of parameters, before continuing to manipulate the installation.
- 10 The welding indicator allows you to quickly verify that the installation is ready.
- 11 Wait at least 1 hour before commissioning the installation with the working pressure.
- 12 **Twenty-four hours after the last joint, you can perform the hydraulic testing of the installation explained in section 7.7.**



Joint parameters:

Diameter (mm.)	Length of penetration (mm.)	Electrical resistance (Ohms)	Time for welding (seconds)	Time for cooling (minutes)
63	58	2.9	110	15
75	64	1.4	110	15
90	72	2.2	160	15
110	80	1.0	220	15
125	90	1.3	345	15
160	100	2.0	780	15

* Parameters valid for the NT electrofusion sleeves, consult the values for other types of fittings such as reduction adaptors or T connectors.

Recommendations to ensure a good joint:

- It is very important to ensure that all the joint surfaces are clean. The presence of drops of water, grease or any other element in the joint area can cause the joint to fail.
- Always check the penetration length of the pipe in the fitting; to do this, mark the pipe beforehand.
- It is recommended to verify that the gap between the pipe and the sleeve is acceptable. Very large gaps leave openings in the joint that do not help the joining process. This gap can be monitored during the reaming process and when aligning the pipe and the sleeve.
- We recommend properly aligning the pipe or fitting with respect to the sleeve. Angular misalignment can cause a joint to fail. According to the DVS standards at 300 mm from the joint the offset of the pipe must be a maximum of 1 mm. The gap between the pipe and the sleeve must be uniform throughout the circumference.
- Once the joint is finished, is very important to wait for the recommended cooling time. Manipulation of the installation before the joint is sufficiently cooled can damage the internal welding performed.
- Use a reliable electrofusion machine and capable to deliver the appropriate voltage and current to make the joint. We recommend using machines that fulfil the characteristics listed in the standard DVS 2208.

Possible assembly errors and their consequences:

ASSEMBLY ERROR	CONSEQUENCE
Insufficient penetration depth	Welding area not covered with possible short circuit and over-welding of the element. Joint not correct.
Dirt in pipe or fitting	Dirt prevents the surfaces melting properly. Joint not correct
Piping with prolonged exposure to light	The exterior layer of the pipe may have rusted. The joint may not be correct.
Pipe and fitting misaligned	Possible leakage of melted material in the openings due to misalignment. Joint not correct
Inadequate welding parameters. Insufficient welding time	The material does not melt. Joint not correct, and the pipe may come out.
Inadequate welding parameters. Excessive welding time.	The material is excessively melted and there is the possibility that the joint will lose melted material. Joint not correct, with possible leakage.

7.4. Butt fusion joint

Joint between pipe and fitting face to face at their thickness. Safe and reliable joint, saving space and material. Depending on whether the installer has good training, knowledge of the machinery and sufficient space and the appropriate position.

Tools necessary for installation

- Commercial butt fusion joint machine with plate temperature of 260°C
- Pipe cutter
- Clock and data table
- Alcohol for cleaning

Personnel able to make the joint

The joints must be made by staff trained in butt fusion techniques and with practical knowledge in the use of the welding machine used.

Instructions for assembly:

- 1 Place the pipes or fittings to be joined in the brackets of the welding machine.



- 2 Check that the thicknesses of both fittings are similar. Close the clamps and verify that the pipes and/or fittings are well aligned, bringing the faces together with the tensing device.
 - The maximum acceptable misalignment corresponds to 10% of the wall thickness.

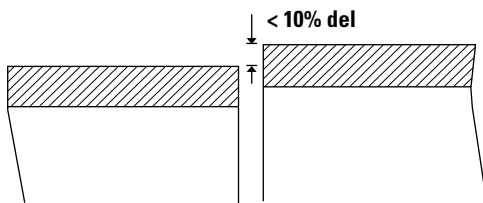

- 3 Clean off any dirt from the faces and the surrounding area. Place the milling tool between the faces and start the machining process.





- 4 Remove the milling tool and clean up any shavings.
- 5 Verify that the two faces are joined with the tensing device there are no excessive gaps in the joint. The maximum must not exceed 0.5 mm.



- 6 Verify that the heating element is at the proper temperature. (260°C)
- 7 Place the heating element between the two fittings.



- 8 Bring the faces towards the heating element and apply a pressure of 0.1 N/mm².
 - In mechanical machines, apply the force called F1 in the attached table.
 - In hydraulic machines, it will be necessary to calculate the pressure to apply to the cylinder.



- 9 Maintain this pressure until the bead formed has sufficient height.
 - The recommended bead dimensions are in the attached table.

Release the pressure to 0.01 N/mm²

- In mechanical machines, apply the force called F2 in the attached table.
- In hydraulic machines, it will be necessary to calculate the pressure to apply to the cylinder.

Maintain this pressure for the time established as T1 in the table attached.



- 10 Separate the faces from the heating element and remove it.
 - It is advisable to perform this step as quickly as possible, the recommended time corresponds to T2 in the table attached.
 - Before removing the heating element, verify it is not stuck to the faces of the fittings to avoid damaging the weld bead.
- 11 Bring the faces closer to begin the joint.
- 12 Increase the pressure during time T3 until it reaches 0.1 N/mm²
 - In mechanical machines, apply the force called F3 in the attached table
 - In hydraulic machines, it will be necessary to calculate the pressure to apply to the cylinder.
- 13 Maintain this pressure for the time established as T4 in the table attached.



- 14 Release the clamps and remove the fittings of the machine.
- 15 Although the joint is already finished it is recommended to wait approximately one hour until the joint has cooled completely before handling the fittings welded.
- 16 Wait at least 1 hour before commissioning the installation with the working pressure.
- 17 **Twenty-four hours after the last joint, you can perform the hydraulic testing of the installation explained in section 7.7.**

Joint parameters

Parameters and diagram for joints with manual tightening machine (mechanical requirements and tests).

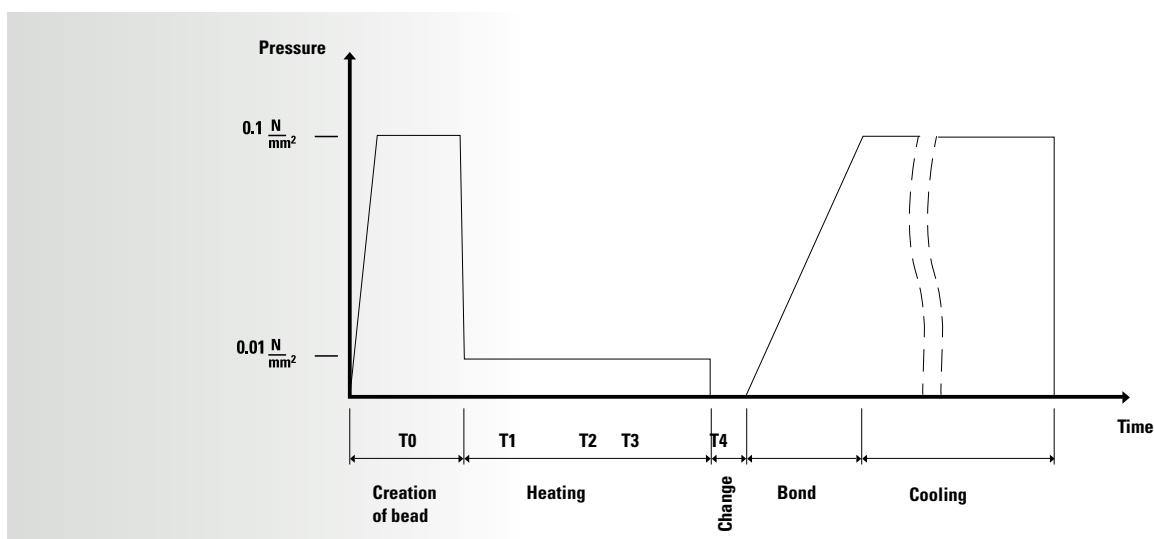



Pipe	0.1 N/mm ² F1 N	T0 sec	Bead mm	0.01 N/mm ² F2 N	T1 sec	T2 sec	0.1 N/mm ² F3 N	T3 sec	T4 sec	Temp °C
Ø63 x5.8	104	HC*	0.5	11	55	6	104	10	8	260
Ø75 x6.8	146	HC*	0.5	15	60	6	146	10	9	260
Ø90 x8.2	211	HC*	1	21	70	7	211	11	10	260
Ø110 x10	314	HC*	1	32	80	7	314	11	12	260
Ø125 x11.4	407	HC*	1	41	85	8	407	12	14	260
Ø160 x14.4	667	HC*	2	67	100	10	667	16	16	260

*HC= Until the bead is made

Recommendations to ensure a good joint:

- After welding, the joint area must look like a double weld bead with a regular shape throughout the circumference, where the intermediate area (trough) is always higher than the exterior face of the fittings (see figure).
- If the welding is done outdoors, it is recommended to protect the joint from adverse weather conditions (rain, snow, wind, etc.) that can cause unacceptable variations in the melting point that is reached.

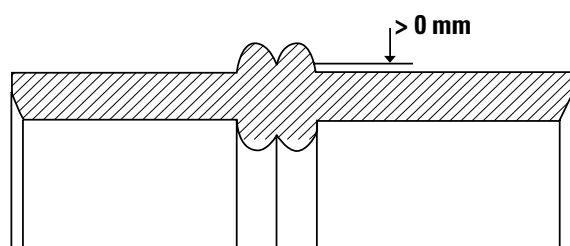

Possible assembly errors and their consequences:

ASSEMBLY ERROR	CONSEQUENCE
Misaligned faces between the pipe and fitting	Irregular weld surface with possibility of breakage. Joint not correct
Insufficient heating time	Material in the joint area cold, welding of the fittings incomplete. Possibility of breakage. Joint not correct.
Excessive heating time	The material can be degraded and may not join correctly. Excessively melted material may spill in the interior of the pipe fitting. Joint not correct
Excessive joint force	Weld bead irregular with non-rounded edges. Joint not correct
Insufficient joint force	Weld bead with possible interior gaps. They may not be visible to the naked eye. Joint not correct
Heating plate dirty	Contamination of the surfaces to be joined causing the joint to fail.
Incorrect temperature of the heating plate (high or low)	Insufficient welding between the surfaces to be joined. Joint not correct

7.5. Flanged joint

The outlets of the PB piping system to commercial elements in large diameters can be made by standard flanged joints. Flanged joints are very sensitive to tangential stresses and overtightening of the flange adaptor. It is important, therefore, to ensure the flanged joint is installed properly, and that it is secured in such a way that it does not receive other stresses from the installation aside from the inherent hydraulic stresses.

Be sure to follow the instructions set out below.

Tools necessary for installation

- Set of flanges, flange adaptors and gaskets supplied by Nueva Terrain
- Recommended fasteners
- Open-ended spanner

Personnel able to make the joint

The joints must be made by staff trained in plumbing and with enough experience in the joint of flanged joints with plastic components.

Instructions for assembly:

- 1 Verify that you have all of the parts necessary to carry out the joint.

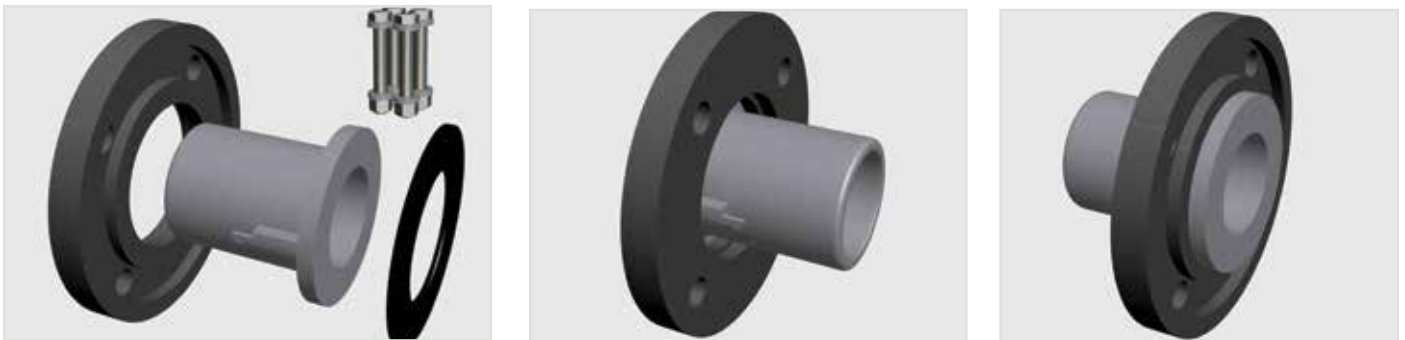

- 2 Enter the flange in the fitting smooth of this towards the external circuits of the joint (otherwise the heads of the bolts will not be correctly seated).

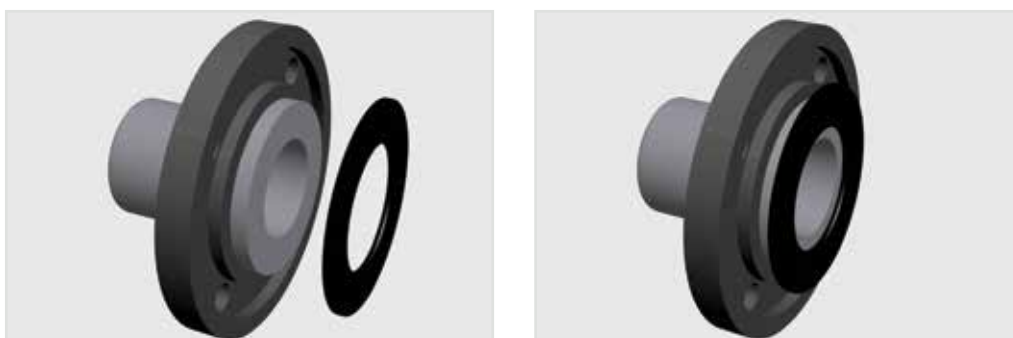



- 3 Place the gasket against the face of the flange adaptor. We recommend you use the gasket supplied by Nueva Terrain exclusively.

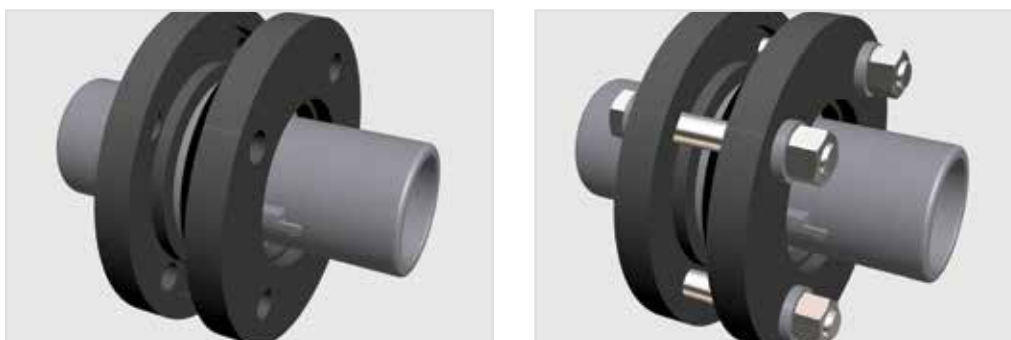

- 4 Place the assembly with the gasket touching the joint you are going to make. Place the bolts with their corresponding washer and uniform tightness.

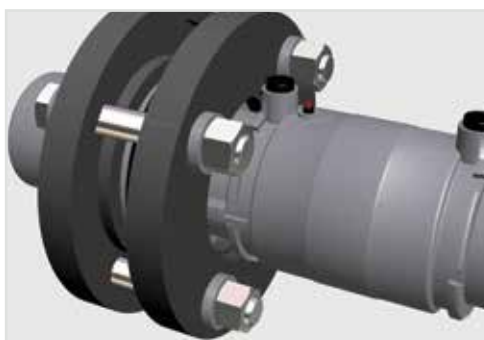

IMPORTANT:

Do not insert the sleeve before the flange as it will not fit afterwards and will be rendered useless.

- 5 If you are continuing the installation with electrofusion joints, insert the coupler into the flange adaptor. The coupler must be positioned at the end of the process because it does not let the flange adaptor pass.

Joint parameters:

Table of parameters for the flanged joint:

Diameter of the joint	Tightening torque (N/m)	No of bolts	Bolts dimension
63	30	4	M16 x 80
75	35	4	M16 x 90
90	40	8	M16 x 100
110	45	8	M16 x 100
125	50	8	M16 x 100
160	-	8	M20 x 140

Gasket data:

Diameter of the joint	External D (mm)	Internal D (mm)	Thickness (mm)	D of bolt (mm)
63	107	63	4	5
75	127	75	4	5
90	142	90	4	5
110	162	110	5	6
125	162	123	5	6
160	218	-	6	8

Flange data:

Diameter of the joint	External D (mm)	Internal D (mm)	Thickness (mm)	Centre holes D	No of bolts
63	171	78	20	125	4
75	191	92	21	145	4
90	206	110	21	160	8
110	226	133	22	180	8
125	226	133	22	180	8
160	296	188	27	240	8

Dimensions of the flange and gasket according to standard DIN 2501 PN10

Recommendations

- The coupler must be positioned at the end of the process because it does not let the flange pass.
- We recommend using the components supplied by Nueva Terrain to carry out the joint; this ensures full compatibility of all the elements.
- Do not install flanged joints in pipe sections with bends or in areas designed for thermal expansion.
- Before starting to tighten the bolts, the faces of the flange adaptors must be in contact and well seated. Forcing the joint of the two sections by tightening the nuts can lead to stresses that can hinder correct system operation.
- Tighten the bolts crosswise as uniformly as possible until the gasket is secured between the flange adaptors. Then tighten with dynamometric wrench to the torque recommended.
- Check the torque 24 hours after making the joint and after the pressure test.
- We recommend lubricating the threads to facilitate the removal of the joint.
- Do not apply grease or lubricant to the gasket.
- Use washers on the nuts and bolt heads and ensure they do not protrude more than 3 or 4 turns of the thread out of the nuts.
- It is recommended to follow the instructions for working with flanged joints in the standard DVS 2210-1.

7.6. Transition joints

Plumbing and heating installations require the inclusion of components external to the piping system, such as taps, impeller pumps, meters, etc. Generally these external components are connected with threaded or flanged joints, in which the piping system and fittings must offer the possibility of coupling this type of joints.

Threaded fittings:

Nueva Terrain has a wide range of metal and plastic fittings with standardised BSP threaded output, that are at the same time suitable for connection to PB pipes.

These fittings are available in diameters from 15 mm to 50 mm for different applications.



Instructions for assembly

- 1 The fittings with a metal thread will be fitted with Teflon on the thread and screwed into the joint, tightened firmly but without forcing the components.



- 2 Use Teflon on the male thread when joint plastic fittings (never apply oakum).



- 3 DO NOT apply Teflon or oakum to the female thread of plastic fittings, as they already have a gasket that makes the seal. Ensure that the male thread is long enough to go all the way in and make the seal with the gasket.



Use the torque recommended in the following table:

Diameter	Torque (N/m)
1/2 " BSP	4
3/4 " BSP	5
1" BSP	6

Threaded fittings with large diameters :

As an alternative to flanged joints for diameters of 63, 75 and 90 mm, Terrain offers joint with a threaded output, that is simpler and less sensitive to the strict conformity of the joint, in addition to functioning as a removable joint and nut for connection.

The joint consists of a removable lock nut and nut that offers many advantages compared to the classic flanged joint.



Installation example

Transition from a 2" ball valve to the PB system.



The nut means this joint is removable and facilitates the installation and maintenance of the system.

In this case, the joint is made after having performed the electrofusion of the PB system and duly secured the valve 2" ball valve.

ND (mm)	ND (BSP thread)	
Ø 63	1/2" BSP	-
Ø 75	¾" BSP	2" H
Ø 90	1" BSP	3" H

Direct connection to copper pipe:

Some of our diameters are compatible with those of copper piping (15, 22 and 28 mm). Direct connections to this piping may only be performed if the pipes are properly bevelled, the dimensions are compatible and the copper quality is sufficiently ductile for our grab ring to grip.

Nevertheless Nueva Terrain recommends the use of transition threaded fittings for the joints between different materials.

The output threads are compatible with the BSP threads. The quality of the brass for stamping is according to alloy CW617N according to standard EN 12165

7.7. Leak testing in the installations

In addition to (or in the absence of) testing by the competent organisation of each country or region require for the validation of the installations, **Nueva Terrain recommends performing the following protocol.**

- 1 Fill the circuit with water.
- 2 Bleed it well in the high areas of the circuit so that there are no air bubbles that could create an overpressure.

ATTENTION: It is very important to remove all of the air from the circuit.



- 3 If there is a considerable difference in temperature ($>10^{\circ}\text{C}$) between the water mains and the room temperature, it is advisable to wait at least 30 minutes for the heat balance to be reached and thus avoid changes in pressure in the circuit due to expansion.
- 4 Raise the pressure to 7 bar for half a minute for the grab ring to catch on the PB pipe.
- 5 Continue increasing the pressure until it reaches 20 bar and leave it at this pressure for 10 minutes to detect any possible leaky joints.
- 6 Lower the pressure to 1 bar for 5 minutes and raise it again to 20 bar for another 10 minutes, to test the joint at dynamic load for cyclical pressure. Repeat this process once more and leave the pressure at 20 bar for 60 minutes.
- 7 Lower the pressure to 3 bar to check the seal of the joints. The pressure test is considered successful if the pressure after 90 minutes remains at ≥ 3 bar. In contrast, if during this time the pressure drops, this is indicative of leakage.

The pressure test is a guarantee that the installation is properly fitted. Nevertheless, marking the joints correctly and ensuring the pipe penetrates the fitting properly are essential for the safety of a good installation. A fitting that is poorly fitted and “gripped” at the end of the pipe may pass the pressure test and come loose later with the dynamic load of the installation.

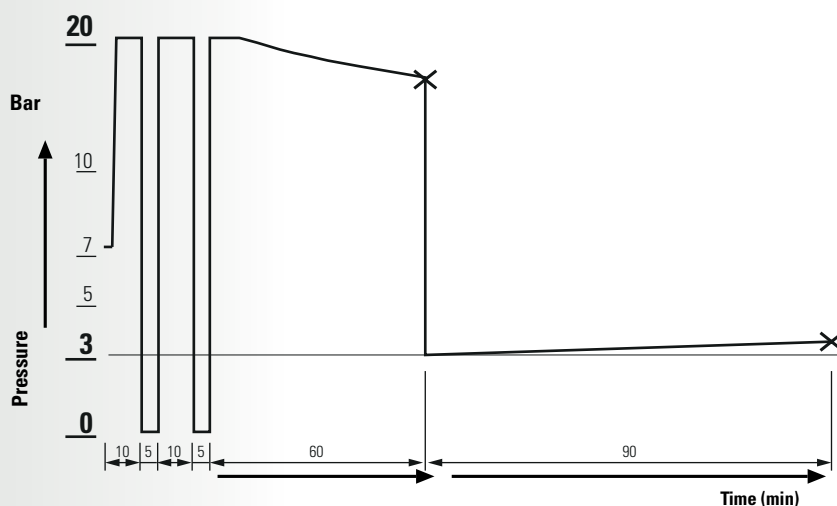

Another way to test the hydrostatic pressure, unlike the previous system, and according to the standard UNE ENV 12108 Method A is set out below:

- 1 Fill the installation with water.
- 2 During the filling of the installation, bleed it to remove all air from the circuit.
- 3 Once the filling of the installation is complete and all the air has been removed, close the water intake.
- 4 Apply the test pressure to the installation, which will have a value of one and a half times the working pressure (but never more than 24 bar). Due to the elasticity of the material the pressure may drop, therefore every 10 minutes the initial value of the test pressure must be restored. This procedure must be repeated three times. During the full 30 minutes, make a visual inspection to check for leakage in the installation.
- 5 After these 30 minutes, reduce the value of the pressure to half the working pressure by opening the drainage valve.
- 6 During the following 90 minutes check for possible leakage in the installation. If during this time the pressure drops, this is indicative of leakage.

ATTENTION: In the event of testing at very high pressure, ensure all components that do not resist this pressure (accumulators, appliances, flanged joints, etc.) are disconnected during the pressure test.

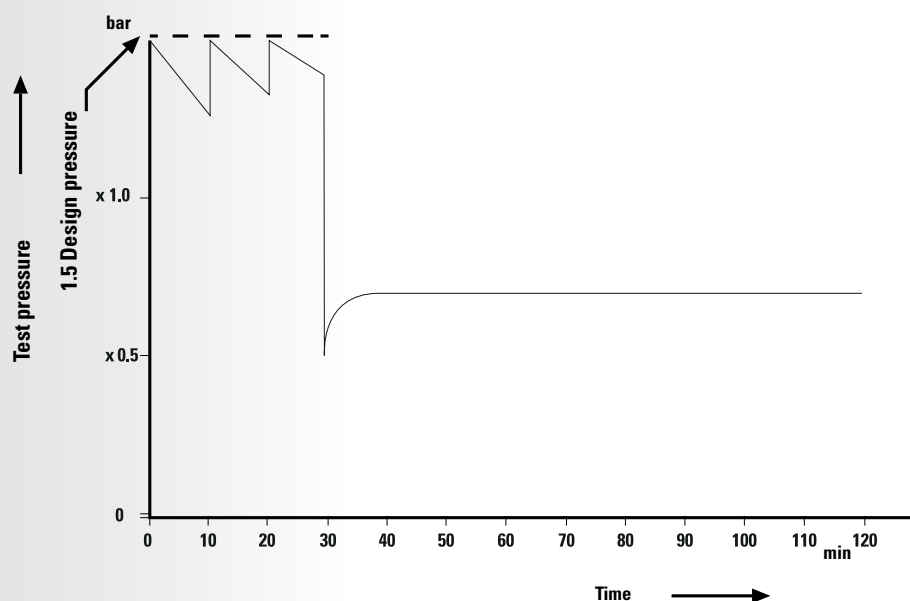



RECORD OF PROOF OF INSTALLATION

Description of the installation

Installation: _____

Location: _____

Circuit: _____

Installer: _____

Check-list for joints

Depth marking for all joints? YES NO N/A

Manipulation or reuse of fittings or joints? YES NO N/A

Cleanliness of all welded joints? YES NO N/A

Parameters for welded joints observed? YES NO N/A

The test conditions

Bleeding? YES Temperature _____ °C Date/Time: _____ / _____

Protocol and recording of the test

Pressure of anchoring: 7 bar - 1 minute

Initial pressure: 20 bar - 10 minutes Final pressure: _____ bar

Pressure at rest: 7 bar - 1 minute

Pressure pulse 1: 20 bar - 10 minutes Final pressure: _____ bar

Pressure at rest: 1 bar - 5 minutes

Test pressure: 20 bar - 60 minutes Final pressure: _____ bar

Working pressure: 3 bar - 90 minutes Final pressure: _____ bar

Date: _____ Name: _____ Signature: _____

8. Flow rate and head loss

8. FLOWS AND HEAD LOSS

8.1. Installation dimensioning

8.2. Head loss in pipes

8.3. Localised head loss

8.4. Temperature correction factor

8.5. Head loss for handling other fluids

8.6. Calculation example

The ultimate objective of the piping network is for sufficient flow of water to reach the points of supply. The test of our installation occurs when the user turns on the tap. The evaluation is ongoing, because our customers repeat this test throughout the whole life of the installation. The installation project is usually universal regardless of the type of material. Nevertheless, the final response of the system does depend on some typical factors of each material and system.





8.1. Installation dimensioning

The pressure and flow reaching the supply point will depend on the correct design of the piping installation, the geodetic height, as well as the incoming pressure from the supply network. The dimensioning of a piping system is a complex problem that must take into account a variety of calculation grounds and parameters, as well as complex hydraulic equations which simulate the flow of the installation. The necessary parameters and calculations for the design of an installation can be summarised as:

- The flow required per section, based on the demand of each appliance and on the application of the simultaneity coefficient in the use of the installation.
- The speed of circulation of the fluid, which must be established by the designer, anticipating possible problems due to a high velocity, such as water hammer or noise generation. In this respect, PB pipe are the most elastic on the market, and PB is the material that best tolerates an increase in circulation velocity.
- The water pressure of the supply network at the intake of the installation.
- The required minimum pressure that reaches each appliance or consumption point.
- The calculation of the head loss of the installation, once the diameters that provide the defined flows and velocities of the fluid have been determined, and compliance with pressure specifications in the points of supply have been verified.

As stated above, the mathematical calculation is complex, since it has to use empirical formulas to simulate the hydraulic behaviour of the piping system. It is not the purpose of this manual to stress what is available in the technical literature for more interested readers. So we will set aside fluid mechanics, laminar and turbulent systems, the friction coefficient and kinematic viscosities, etc. as well as their mentors Bernoulli, Colebrook, Reynolds, Darcy, etc. and we will focus on the simplified solutions that make dimensioning possible, simply and properly.

Thus, there are a number of standards that define the process of dimensioning and the calculation of the head losses that are simplified and objective, using hydrodynamic principles, as well as experience with installations.

To name a few, the most relevant are:

UNE EN 806-3: Specifications for installations of water intended for human consumption inside buildings. Dimensioning of the piping. Simplified method.

UNE 149201: Dimensioning for installations of water intended for human consumption inside buildings

ISO/TR 10501 – UNE 53959: Thermoplastic pipes for the transport of pressurised liquids. Calculation of head loss

CTE DB HS4: Cold water supply. Section 4: Dimensioning

The problem of dimensioning, described in the cited standards, is resolved sufficiently, even with software programmes that automate the calculation. If you have further questions or questions, our technical office can advise you and even draw up the project in more specific or exceptional cases.

In any event, and beyond the theoretical calculations set out in the projects, remember the advantages of Terrain SDP PB system, in terms of the correct and reliable supply in the conditions of the project:

- ==> An extremely elastic material, which results in very good functional performance in the event of high circulation speeds: noise is not generated, extreme pressure peaks due to water hammer are not reached, etc.
- ==> The material has smooth walls that maintain the same roughness throughout its useful life, and therefore it ensures the continuity of supply in the conditions of the project, compared to the piping and fittings that suffer corrosions and/or limescale deposits, increasing the losses and reducing the flow.
- ==> Fittings and joint system that does not restrict the passage of fluid, and therefore does not increase localised losses.

8.2. Head loss in pipes

Annex 5 shows the table of head losses, according to the flow transported or the flow velocity, for all PB piping in the Terrain SDP catalogue and in the working range of the plumbing installations.

The units in which the head loss data is expressed are mbar per metre of pipe, for a water temperature of 20°C.

If you need calculate the head losses in a different working range to that set out, consult our Technical Department or apply the **general formula set out in the calculation standard ISO/TR 10501:**

If the Reynolds number is set to: $4 \times 10^3 \leq Re \leq 1.5 \times 10^5 \rightarrow J_0 = 5.37 \times 10^{-2} \times (d-1.24 v^{1.76})$

If the Reynolds number is set to: $1.5 \times 10^5 \leq Re \leq 1 \times 10^6 \rightarrow J_0 = 5.79 \times 10^{-2} \times (d-1.20 v^{1.80})$

Where: J_0 is the head loss of the pipe in mbar per metre of pipe at 20°C

d is the internal pipe diameter (m)

v is the circulation velocity of the fluid in the pipe in m/s

8.3. Localised head loss

Head loss due to the fittings that comprise the piping system is calculated by applying a universal multiplication coefficient defined for each figure or shape according to the following formula, which evidently takes into account the average velocity of the water transported. The calculation formula used is that proposed in the standard ISO/TR 10501:

$$\Delta P = \frac{100 \xi V^2}{2 g}$$

Where: ΔP is the localised pressure drop (mbar)

ξ is the pressure drop coefficient, determined per type of fitting (dimensionless)

v is the speed of the fluid (m/s)

g is the acceleration due to gravity: 9.8 m/s²

The values of ξ for each fitting, based on the explained calculation are given below.



Fitting No.	Type of fitting	Coefficient		Graphic symbol
1	T divergent	1.3		
2	T concurrent	0.9		
3	Manifold outlet	0.5		
4	Manifold inlet	1.0		
5	Elbow or curve	0.7		
6	Reduction	0.4		
7	Expansion loop	1.0		
8	Screw down valve	Ø15	10.0	
		Ø16	10.0	
		Ø20	8.5	
		Ø22	8.0	
9	Ball valves	Ø15	1.0	
		Ø22	0.5	
		Ø25	0.5	
		Ø28	0.5	
		Ø32	0.3	
10	Angle valve	Ø15	4.0	

8.4. Temperature correction factor

The calculations and values expressed above for the head loss in pipes are only for water at 20°C as the fluid piped. The pressure drops are, nevertheless, dependent on the temperature of the fluid piped, as at higher temperatures the kinematic viscosity the fluid is lower and therefore the friction and head losses are also reduced. Although the value of the correction coefficients depends to a lesser extent on the hydraulic system where it is flowing, according to the Reynolds number that characterises it, the values can be accepted as fixed according to the following table:

T (°C)	0	5	10	15	20	25	30	35
kt	1.123	1.087	1.055	1.027	1.000	0.977	0.956	0.937

T (°C)	40	45	50	60	70	80	90	100
kt	0.918	0.903	0.886	0.858	0.834	0.813	0.793	0.776

The losses at a temperature t , ΔP_T , therefore, are calculated with reference to the losses at 20°C (J_0), multiplied by the correction factor from the table above, with the following formula:

$$\Delta P_T = kt J_0$$

8.5. Head loss for handling other fluids

If you want to calculate the head loss for piping a liquid other than water, you need to know its kinematic viscosity, at the temperature of the project, applying the following formula that links the losses of the fluid to calculate with those of water at 20°C .

$$\Delta P_x = J_0 (v_x / v_w)^b$$

Where: ΔP_x is the unitary head loss for a given liquid.

J_0 is the unitary head loss for water at 20°C

v_x is the dynamic viscosity of a given liquid at the temperature of the project.

v_w is the dynamic viscosity of water at 20°C .

The exponent b in function of the type of hydraulic system of the fluid, depending on the value of the Reynolds number that characterises it:

If the Reynolds number is set to: $4 \times 10^3 \leq Re \leq 1.5 \times 10^5 \rightarrow b = 0.24$

If the Reynolds number is set to: $1.5 \times 10^5 \leq Re \leq 1 \times 10^6 \rightarrow b = 0.20$

8.6. Calculation example

Suppose you have 10 m of $\varnothing 32 \times 2.9$ pipe installed along with four 90° elbows and water circulates in this installation with a flow of 0.8 l/sec.

- 1.- According to the tables in Annex 5, the head loss in the pipe is 9.6 mbar/m with a fluid circulation velocity of 1.48 m/sec. Therefore, the head loss in the 10 metres of pipe is 96 mbar.
- 2.- According to the table in point 8.3, for the elbow, the coefficient ξ has a value of 0.7. Applying the formula for a velocity of 1.48 m/s, you will obtain an individual head loss of 7.82 mbar. As you have 4 fittings, the head loss in all of them will be 31.3 mbar.
- 3.- Therefore the total head loss in our installation is 127.3 mbar.
 - 96 mbar due to the pipe
 - 31.3 mbar due to the fittings



9. EXPANSION, COMPENSATION AND CLAMPS

9.1. Expansion and compensation

9.1.1. Expansion and stress in different materials

9.2. Installation techniques

9.2.1. Installation of variable length pipes

9.2.1.1. Placement of the anchor points

9.2.1.2. Compensation of the variation in length using an expansion offset

9.2.1.3. Compensation of the variation of the length with a loop

9.2.1.4. Examples of expansion absorption using expansion offsets and loops

9.2.1.5. Installation of clamps for installations that allow variations in piping length

9.2.1.6. Compensation of the length variation with continuous horizontal supports

9.2.1.7. Installation of assembly columns with “natural loops”

9.2.2. Installation of non-variable length pipes

9.2.2.1 Recommendations for fixed-assembly installations

9.2.2.2 Distances between clamps for fixed assembly

9.2.2.3 Selection of the threaded rod for securing clamps

9.2.2.4 Examples of fixed-assembly installations

9.3. Selection of the installation procedure

Compensating expansion, to avoid problems linked to it in hot water and heating installations, is one of the basic questions in the installation project. There are diverse solutions and they depend on each installation. This chapter sets out the constructive solutions that, thanks to our experience, we can provide.



The thermal motion that occurs in the piping installations, its own weight and the hydraulic pressure, as well as the action on control elements such as valves and similar, are a source of stress on the installations that must be taken into account in the design phase, with the aim of preventing any damage to them.

A summary can be found below of the installation techniques, as well as methods for compensation expansion, the selection of fixed points and supports, as well as general recommendations that will help in the construction of safer installations. Even recognising the concurrence that is not always simple between the installation in the drawing (design) and the real installation, following certain basic construction instructions will result in the correct absorption of the stresses generated, without affecting the components of the installation itself: pipes, fittings and joints. First we will provide an overview of the behaviour of expansion in materials, and the generation of stress due to poor compensation of this expansion.

9.1. Expansion and compensation

A general characteristic of all solids is that they expand, to a greater or lesser extent, when their temperature is increased and contract when it is decreased. Thus a bar of any material with an initial length L_0 experiences an elongation ΔL when its temperature is raised by ΔT °C. The constant characteristic of each material that relates these amounts is the coefficient of linear thermal expansion, α , so:

$$\Delta L = \alpha \times L_0 \times \Delta T$$

Where: ΔL is the length increase (mm).
 L is the initial length (m).
 α is the coefficient of linear thermal expansion (mm/m °K).
 ΔT is the temperature increases in °K (=in °C).

The coefficient of thermal expansion for PB is 0.13 mm/m°K, so when the formula is applied we obtain the elongation of the PB pipe for a given temperature increase (alternatively, Annex 6 provides a graph that enables a simpler calculation of length variation for PB pipes.)

These variations, whether elongation or contraction, in addition to eventually causing a negative aesthetic effect (a buckled pipe), there may also be mechanical stress in the pipes themselves and at the anchor points.

While it is true that the coefficient of expansion of plastics is significantly higher than that of metals, the mechanical stress that occurs due to the expansion is much lower in plastics, due to their elasticity. The following chapter analyses the mechanical stress caused by expansion.

9.1.1. Expansion and stress in different materials

As mentioned in the preceding section, the stress generated in installations due to expansion of the piping are dependent on the coefficient of linear expansion and the elastic modulus of the piping material. The elastic or Young's modulus is the factor that links the stress to the elongation, according to the following equation:



$$E = \frac{\sigma}{\epsilon} = \frac{F/S}{\Delta L/L}$$

Where: **E** is the longitudinal elasticity modulus. (MPa)
 σ is the stress on the transverse section of the pipe (MPa)
 ϵ is the unitary deformity of the pipe.
F is the force exerted (N).
S is the surface where the force is applied (mm²).
 ΔL length increase (m)
L Length (m)

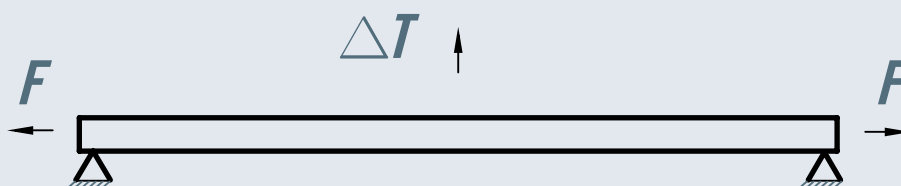

Thus, in the case of the expansion of a pipe between two points, the stress that occurs at the anchors is defined by the equation itself, as the pipe tries to expand longitudinally, but cannot do so due to the fixed points and cannot bend laterally. By developing the preceding equations we obtain the formula that relates the force transmitted to the anchors in a pipe due to a temperature increase T:

$$\sigma = E \cdot \Delta L \rightarrow F = E \cdot \Delta L \cdot S = E \cdot \alpha \cdot \Delta T \cdot S$$

Where **F** is the force that is generated on the supports (N)
 α is the coefficient of linear thermal expansion (mm/m^{°K}) → 0.13 for PB
 ΔT is the temperature increase (°K)
S is the section of the pipe thickness (mm²)

If we take a typical case of a temperature increase of the pipe of 50°C for a commercial pipe with an external diameter of 25 mm in different materials, we will have:

Material	E (MPa)	α (mm/m °K)	D (mm)	e (mm)	F (N)
PB	450	0.13	25	2.3	480
PEX	950	0.20	25	2.8	2245
PP	900	0.15	25	3.5	1595
PVC-C	3500	0.08	25	2.8	2734
Steel	210000	0.012	¾" (26.9)	2.65	25437
Cu	120000	0.018	22	1.2	8468

9.2. Installation techniques

There are different types or methods of installation to correct both the stress and the aesthetic effect of the expansion caused in an installation. The selection of one type or another will depend on the situation and constructive possibilities, as well as the diameter of each section and the foreseen stresses.

Basically, there are two different methods of installation, that in turn can be divided according to how they are applied, and that are explained in detail in the standard ENV 12108 on recommended practices:

1. **Those that allow "longitudinal" expansion of the pipe (expansion offset or loop).** This method does not have a negative aesthetic effect but it is necessary to be very careful when choosing and executing the fixed point (only one in the case of the offset) and/or sliding clamps to guide the expansion. In addition it is necessary to have the space needed to house the expansion offsets or loops.
2. **Those that do not allow linear expansion of the pipe:** the expansion can be seen as a curvature or "buckling" of the pipe, or be corrected with half pipes or continuous supports that cause the expansion in the diameter of the pipe and its compression.

9.2.1. Installation of variable length pipes

This enables the longitudinal expansion of the pipe by making a single fixed point in the section studied and using an expansion offset or loop at the other end to allow it to expand freely.

9.2.1.1. Placement of the anchor points

The selection and placement of the anchor points is used to direct and limit the proportion of the thermal expansion. The fixed or anchor points can be placed in such a way that the variations in length due to the effect of the temperature can be distributed in different directions.

The following figures show examples of the choice of anchor points on uprights. Similarly, they can be applied to the header of the pipes used in a basement.

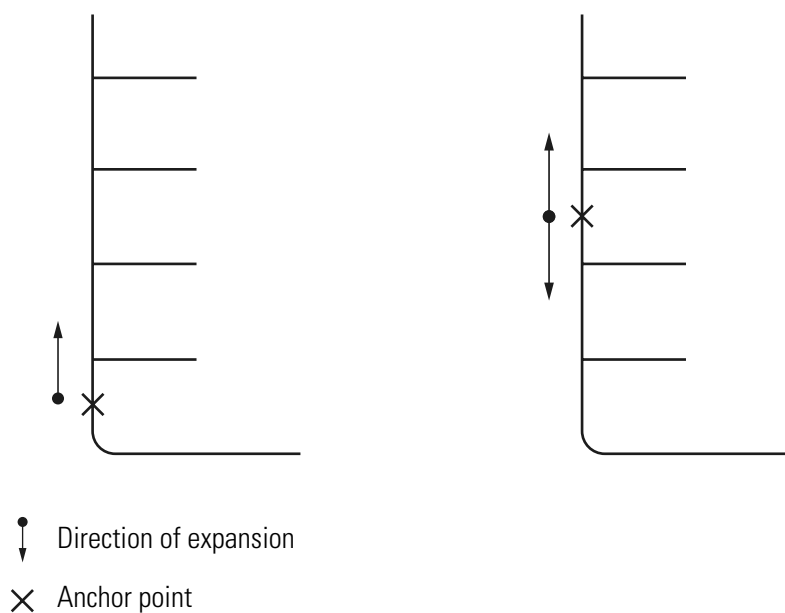

The anchor points or fixed point must be made with suitable clamps that are able to prevent the movement of the pipe while not damaging it. We recommend the use of well-tightened clamps with rubber seals.



9.2.1.2. Compensation of the variation in length using an expansion offset

This method consists of anticipating space joint a expansion offset that allows the pipe to expand. The guide clamps must therefore permit the movement due to the expansion of the pipe so that the expansion offset is at its planned location. The next section explains how to calculate the expansion offsets.

Calculation of the expansion offset

The following figures show two different cases where the expansion offset has been used to allow the installation to expand. In both cases the aim is for the expansion to be absorbed by the bending of the pipe, avoiding mechanical stress on the fittings.



T with expansion offset (with uprights)

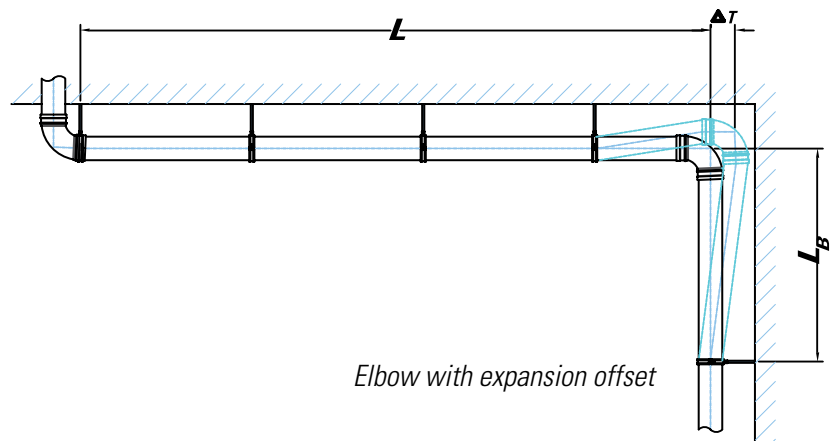

Elbow with expansion offset

In the valuation of these stresses, in addition to the length variation itself, the elastic modulus of the material of the pipe is also relevant, for example, to determine the length of an expansion offset the following formula is used:

$$BF = C \cdot \sqrt{\Delta L \cdot \emptyset}$$

Where: The constant **C** depends on the pipe material:

C = 10 for PB

C = 20 for PP-R

C = 34 for PVC-C

C = 12 for PEX

ΔL = increase in length due to temperature variation (mm)

∅ = external pipe diameter (mm)



Example calculation of the expansion offset:

PRELIMINARY DATA:

- Length of the pipe (L0) = 10 m
- Temperature increase (ΔT)= 50°C
- Pipe diameter (\varnothing)= 40 mm
- Thermal expansion coefficient of PB: 0.13 mm/m°K

First calculate the increase in length of the pipe when its temperature is increased by 50°C using the formula explained in section 9.1:

$$\Delta L = \alpha \times L0 \times \Delta T = 0.13 \times 10 \times 50 = 65 \text{ mm}$$

Applying the formula for the expansion offset you will obtain:

$$BF = C \circ \sqrt{\Delta L \circ \varnothing} = 10 \circ \sqrt{(65 \times 40)} = 509.9 \rightarrow 510 \text{ mm}$$

In the previous case of a 10 m pipe with a diameter of 40 mm and a thermal variation of 50°C the expansion offsets required for different materials are:

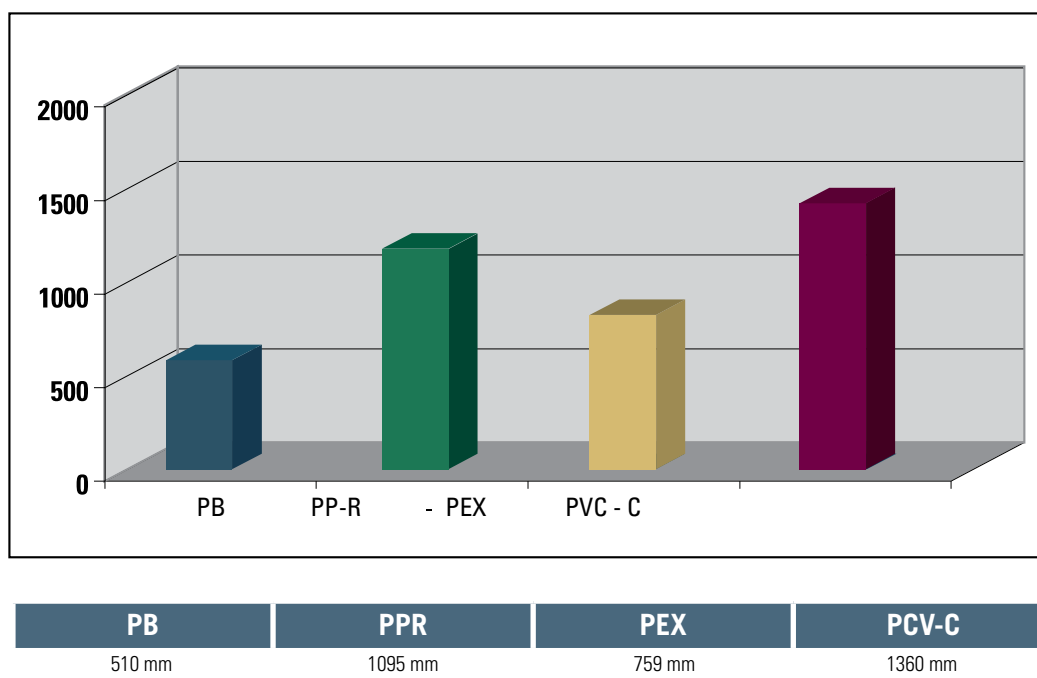

As you can clearly see, PB pipes can absorb the variations in length for the same thermal change using perpendicular expansion offsets that are shorter than for other materials. This difference can be permitted even in some cases where the expansion loop is not necessary in PB but is in other materials.

9.2.1.3. Compensation of the variation of the length with a loop

The expansion loops are placed alternately in the installation when it is not possible to use expansion offsets. This technique consists of interrupting the straight stretches of pipe that expand by alternately placing an artificial expansion offset:

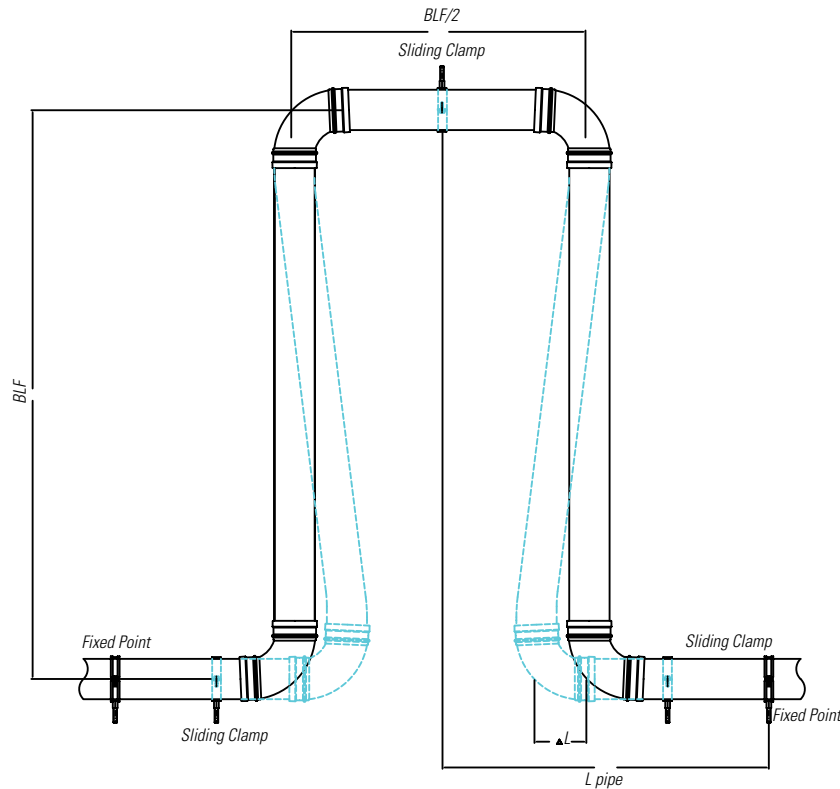

For the expansion loop to function correctly it is imperative that the sliding clamps allow the pipe to slide along them from the fixed point toward the expansion loop.

Calculation of the expansion loop

The calculation of the expansion loop is similar to that of the expansion offset:

$$BFL = C \cdot \sqrt{\Delta L \cdot \emptyset}$$

Therefore, the total length of the expansion loop will be:

$$L_{\text{Total}} = BFL + BFL/2 + BFL = 5 \times BFL/3$$

It is advisable that for the design of the expansion offset, the perpendicular arm be double the length of the parallel, as shown in the drawing.

If the expansion loop is not placed at the mid-point of the stretch of pipe, the longest stretch will be used to calculate the increase in length due to expansion.



Calculation example of a expansion loop:

Suppose we take a straight stretch of pipe of D40 mm, 15 m long, located between 2 fixed points:

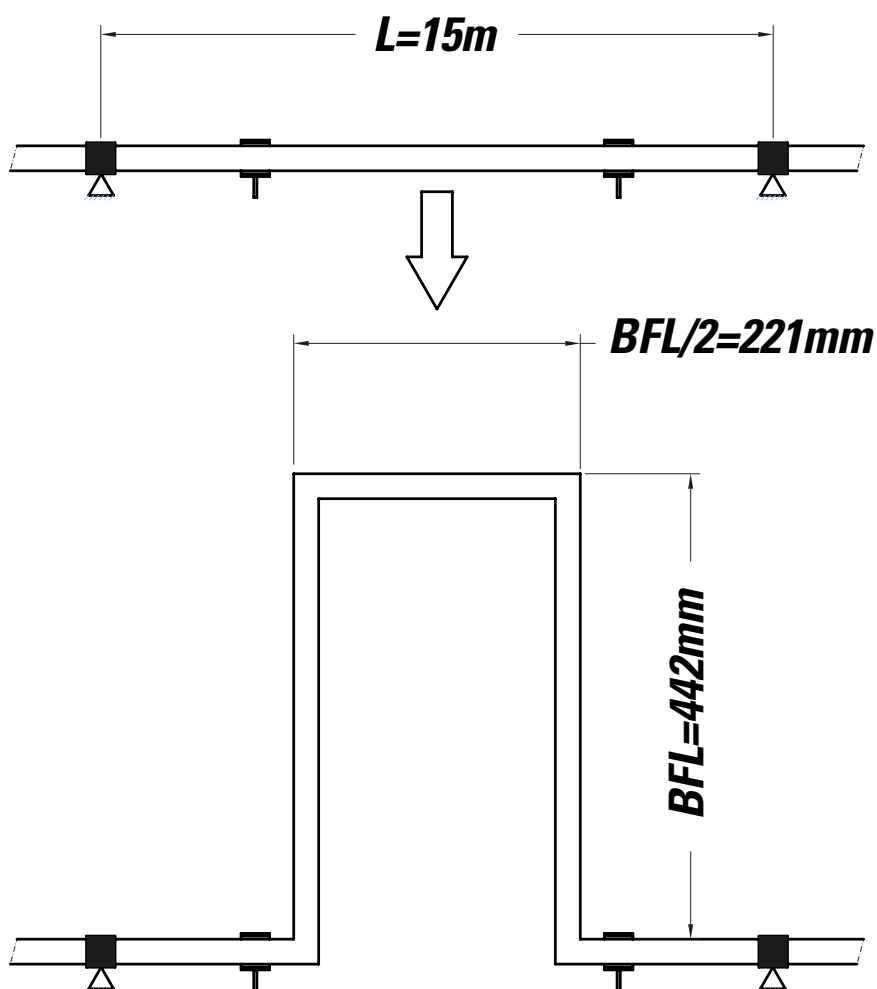

The compensation of expansion with an expansion loop is done as follows:

First calculate the increase in length of each section due to expansion (ΔL) assuming that the expansion loop will be placed at the mid-point of the stretch of pipe.

$$\Delta L = \alpha \times L_0 \times \Delta T = 0.13 \times 7.5 \times 50 = 48.75 \text{ mm}$$

Then calculate it in BFL:

$$BFL = C \cdot \sqrt{\Delta L \cdot \varnothing} = 10 \cdot \sqrt{(48.75 \times 40)} = 441.58 \rightarrow 442 \text{ mm}$$

If the expansion loop is not at the centre of the stretch of pipe, the calculations shall be made with the longest stretch.

9.2.1.4. Examples of expansion absorption using expansion offsets and loops

Example 1:

Take a stretch of pipe D90, 30 m long, with a T outlet at 10 m from one end of D40.

Below you can see a possible solution for absorbing the expansion using expansion offsets and loops.

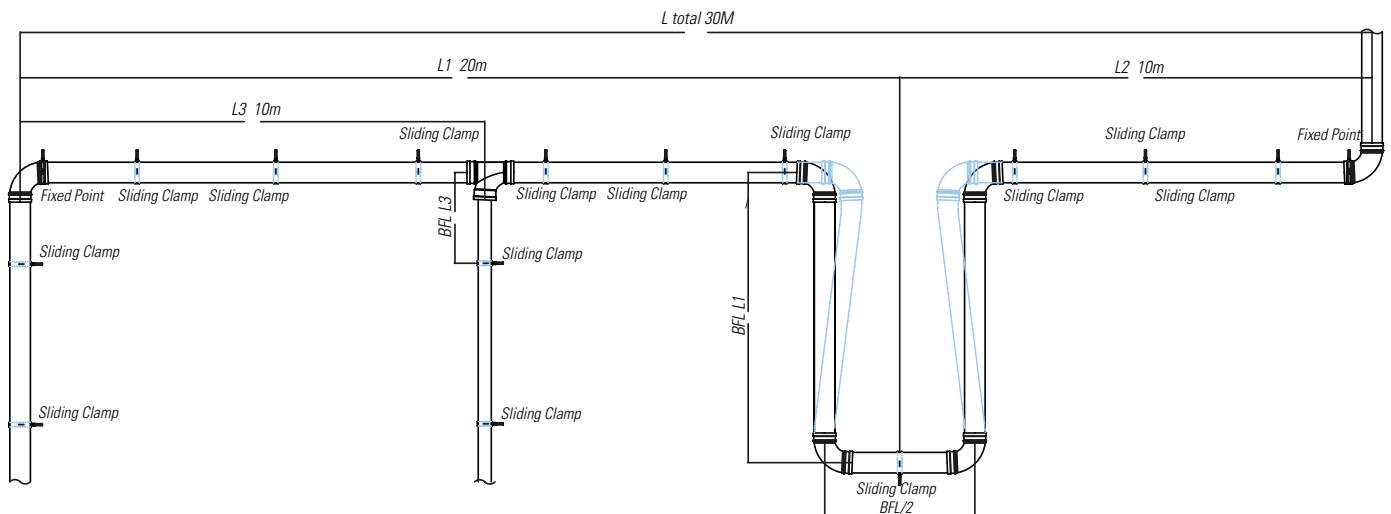

To calculate the values of BFL_3 and BFL_1 take an increase in temperature of 50°C.

Therefore:

$$\Delta L (BFL_3) = \alpha \times L_0 \times \Delta T = 0.13 \times 10 \times 50 = 65 \text{ mm}$$

$$\Delta L (BFL_1) = \alpha \times L_0 \times \Delta T = 0.13 \times 20 \times 50 = 130 \text{ mm}^*$$

* For the calculation of the off-centre expansion loop, we use the longest stretch to calculate the increase in length.

Now calculate the expansion offsets:

$$BF_{L1} = C \cdot \sqrt{\Delta L \cdot \emptyset} = 10 \cdot \sqrt{(130 \times 90)} = 1081.66 \rightarrow 1080 \text{ mm}$$

$$BF_{L3} = C \cdot \sqrt{\Delta L \cdot \emptyset} = 10 \cdot \sqrt{(65 \times 40)} = 509.90 \rightarrow 510 \text{ mm}$$



Example 2:

Suppose the same case as in the previous example but knowing that the D40 mm outlet is too short to use the expansion offset, in this case the solution could be the following:

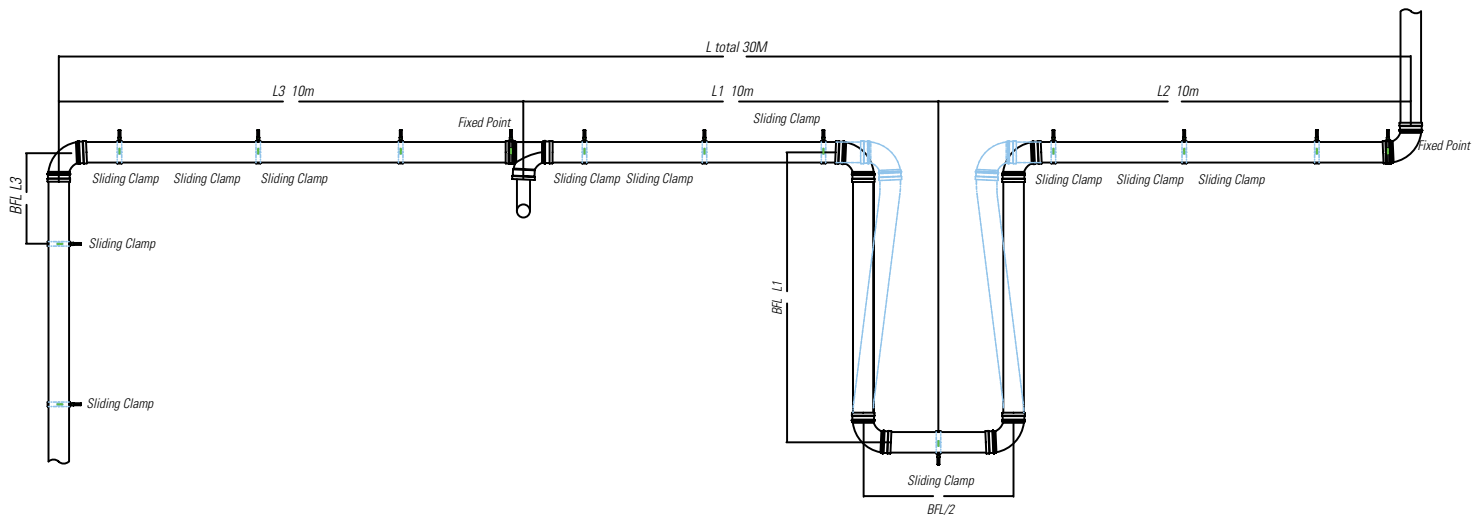

The calculations treatments are the following:

$$\Delta L (BFL_{L3}) = \alpha \times L_0 \times \Delta T = 0.13 \times 10 \times 50 = 65 \text{ mm}$$

$$\Delta L (BFL_{L1}) = \alpha \times L_0 \times \Delta T = 0.13 \times 10 \times 50 = 65 \text{ mm}$$

$$BF_{L1} = C \cdot \sqrt{\Delta L \cdot \emptyset} = 10 \cdot \sqrt{(65 \times 90)} = 764.85 \rightarrow 765 \text{ mm}$$

$$BF_{L3} = C \cdot \sqrt{\Delta L \cdot \emptyset} = 10 \cdot \sqrt{(65 \times 90)} = 764.85 \rightarrow 765 \text{ mm}$$

9.2.1.5. Installation of clamps for installations that allow variations in piping length

The distances recommended for placing the sliding clamps and preventing curvature of the pipe due to expansion, allowing the increase in length to be transmitted to the expansion offsets and loops.

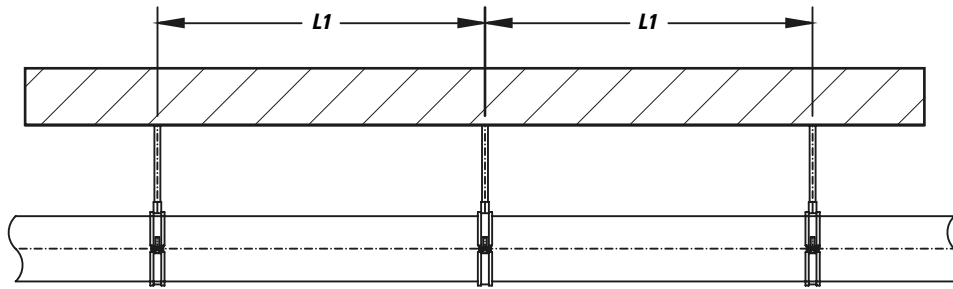
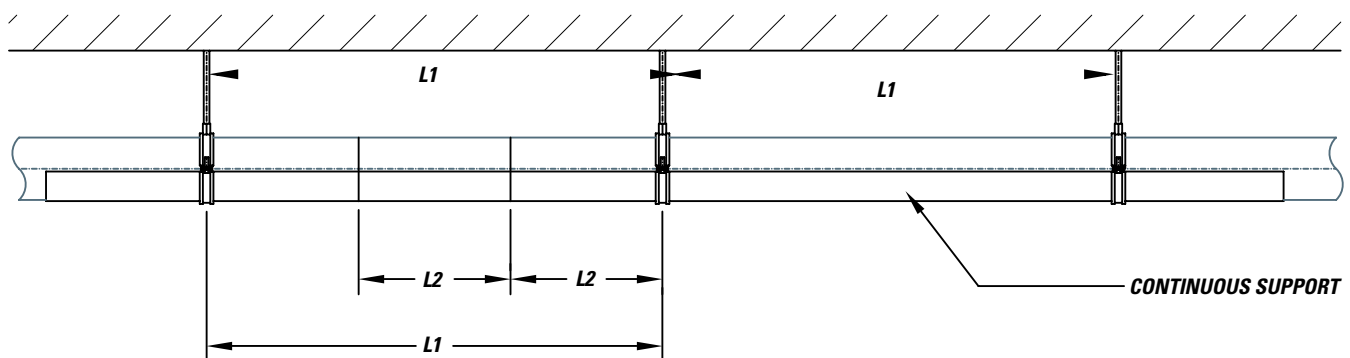

Table A: Distance in L1 for PB piping without half pipes

Diameter (mm)	Cold water L1 (mm)	Hot water (60-70 °C) L1 (mm)
d16mm	750	400
d20/22mm	800	500
d25/28mm	850	600
d32mm	1000	650
d40mm	1100	800
d50mm	1250	1000
d63mm	1400	1100
d75mm	1500	1.200
d90mm	1650	1300
d110mm	1900	1600

For vertical installations, L1 must be multiplied by 1.3

If continuous support (half pipes) is used to secure the installation, the following is recommended:



Continuous support with guide clamps that allow variations in length due to the effects of temperature



Maximum distance recommended between clamps and ties for installations with half pipes

External diameter of the pipe (mm)	Maximum distance between clamps (L1) mm	Maximum distance between ties (L2) mm
D20 to D40	2000	300
D50 to D75	2200	500
D90 to D180	2500	600

9.2.1.6. Compensation of the length variation with continuous horizontal supports

The pipes can be placed on continuous horizontal supports (for example, cable trays) where the increase in length is compensated by the buckling of the pipe. Its layout must be designed to leave enough space for this increase in length. The pipe must be fixed to prevent it moving vertically.

Thus, "natural loops" will occur that will absorb the expansion. This installation technique is possible due to the high flexibility of PB piping, which allows the pipe to "buckle" without exerting stress on the material.



9.2.1.7. Installation of assembly columns with “natural loops”

the problem of expansion is more acute in installations using upright columns in medium and tall buildings. Generally the space through which the piping runs is small and it is complicated to install expansion loops and offsets.

PB, due to its flexibility and resistance, enables the installation of pipes without expansion offsets or loops, simply letting the pipe expand and buckle.

Isophonic clamps shall be installed and fully tightened (fixed points) in the outlets (Ts) to prevent the transmission of stress to the rest of the installation.

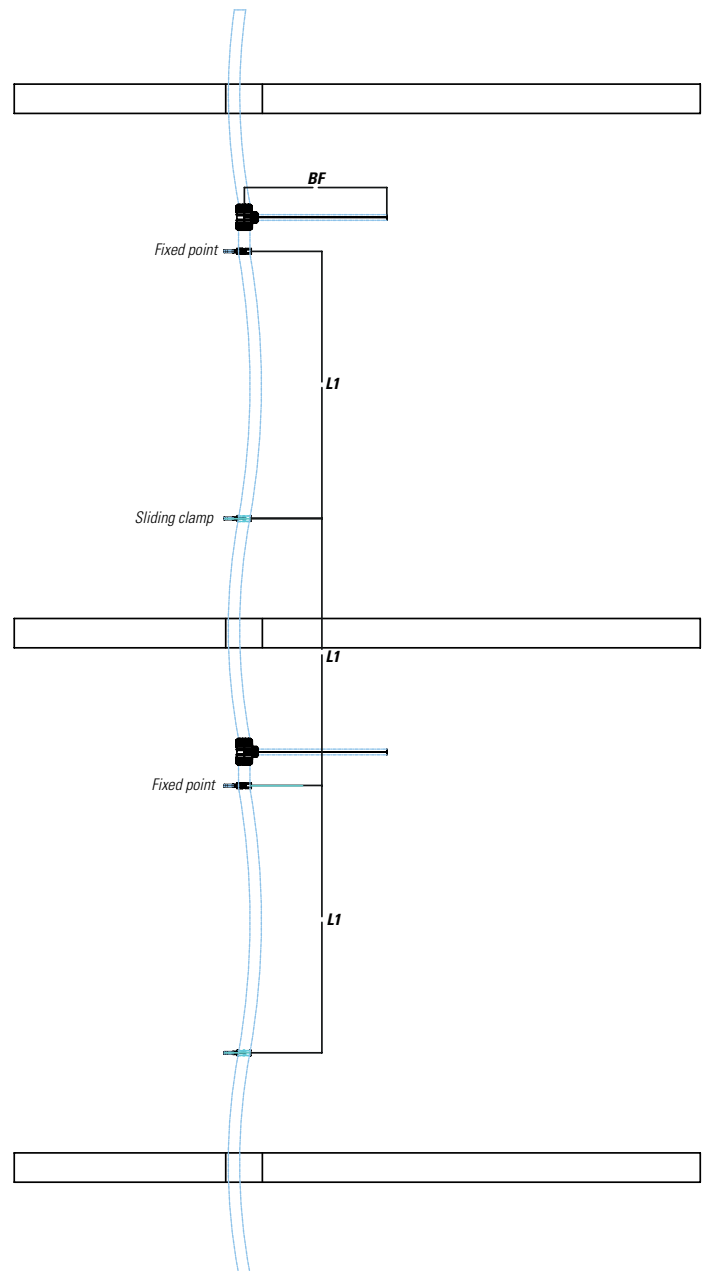

Ext ϕ of the outlet (mm)	Recommended length of the expansion offset (BF) in mm
20	200
25	250
32	280
40	300
50	350

In each outlet there is a fixed point to avoid movement.

A small expansion offset must be left at the outlets to absorb the curvature of the pipe and fitting.



If push-fit fittings are used in the installation, it is possible to dampen the bending of the pipes as these fittings allow the pipe to rotate.



In this case it is not necessary to anticipate expansion offsets in the outlets of the upright.

9.2.2. Installation of non-variable length pipes

It is sometimes not possible to install a mechanism for absorbing the expansion of an installation (due to insufficient space, aesthetic considerations, etc.); in these cases PB is a huge advantage over other materials, as it is possible to install it with “fixed assembly”.

A “fixed assembly” installation consists of installing the pipe and preventing its expansion by means of fixed points and using steel supports (half pipes) to prevent bending.

This type of installation is not suitable for all material, as the expansion forces may be too high/low and damage the pipe and even pull out the anchors. Nevertheless PB due to its high flexibility generates a minimum mechanical stress that is absorbed without damaging the installation, as is shown in the comparative table in section 9.1.1.

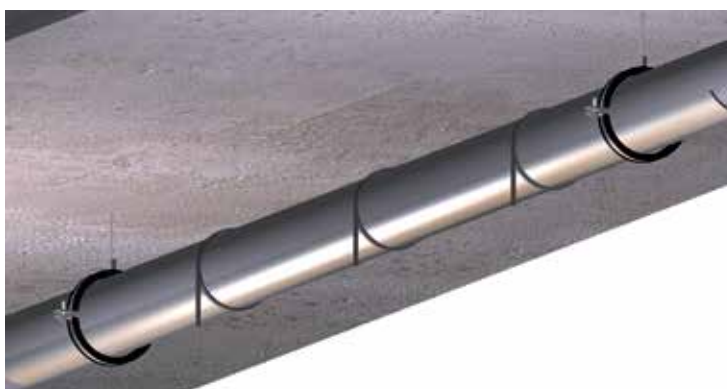

9.2.2.1 Recommendations for fixed-assembly installations

- Always place tightened isophonic brackets as fixed points and steel half pipes accompanying the pipe.
- The half pipes must overlap at least 25 cm for a rigid transition.
- Fit plastic cable ties between the clamps to prevent the pipe lifting out of the half pipes.
- When the stretch of pipe has a decrease in diameter, this point shall always be a fixed point.

9.2.2.2 Distances between clamps for fixed assembly

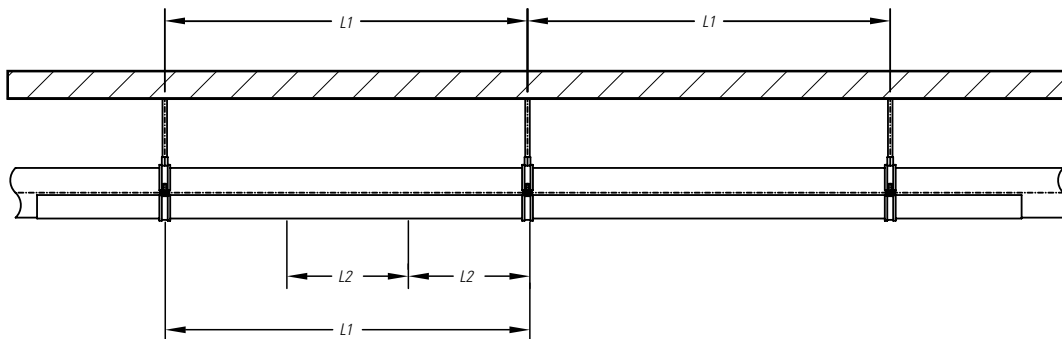

Table B: Distance L1 applying the half pipe

Diameter (mm)	Distance between clamps all temperatures L1 (mm)	Distance between “cable ties” L2 (mm)
d16 - 40 mm	2000	300
d50 - 63 mm	2200	500
d75 - 110 mm	2500	600

NOTE:

It is important to ensure the half pipes do not have sharp edges.

9.2.2.3 Securing clamps

As “fixed assembly” installations transmit part of the expansion forces to the anchor points, it will be necessary to dimension them correctly to avoid bending and even breakage. The clamps must be correctly anchored to the walls or ceilings using appropriate supports.

Depending on the pipe diameter, the working temperature range and the distance to the fixing surface, it will be necessary to use a more or less rigid support to hold the clamps properly.



By following the instructions in section 9.1.1. we can calculate the stress transmitted by the pipe to the fixed points due to the expansion. The following table shows the results obtained when the temperature increase is 50°C:

PB piping	ΔT (°C)	Force transmitted (N)
15x1.7	50	208
16x1.8	50	235
20x2.3	50	374
22x2	50	368
25x2.3	50	480
28x2.5	50	586
32x2.9	50	775
40x3.7	50	1234
50x4.6	50	1919
63x5.8	50	3048
75x6.8	50	4261
90x8.2	50	6164
110x10	50	9189
125x11.4	50	11900
160x14.6	50	19507

The supports shall be dimensioned according to the values of stress calculated, taking into account that a fixed point must not move or bend.

The following table shows the diameter of a steel bar recommended for securing the clamps for each pipe diameter in the event of installations with fixed points:

Distance to wall or ceiling (mm)	Pipe diameter (mm)												
	20	22	25	28	32	40	50	63	75	90	110	125	160
Diameter needed for the steel bar (mm)													
100	8	8	8	8	8	10	10	12	14	14	16	16	16
150	8	8	10	10	10	12	14	14	16	18	18	20	22
200	10	10	12	12	12	14	16	18	20	22	22	24	28
250	12	12	14	14	14	16	18	20	22	24	26	28	32
300	14	14	14	16	16	18	20	24	26	28	30	32	36
350	16	16	16	18	18	20	24	26	28	30	34	36	42
400	18	18	18	20	20	22	26	28	30	34	38	40	46

Calculated for a temperature variation of 50°C.

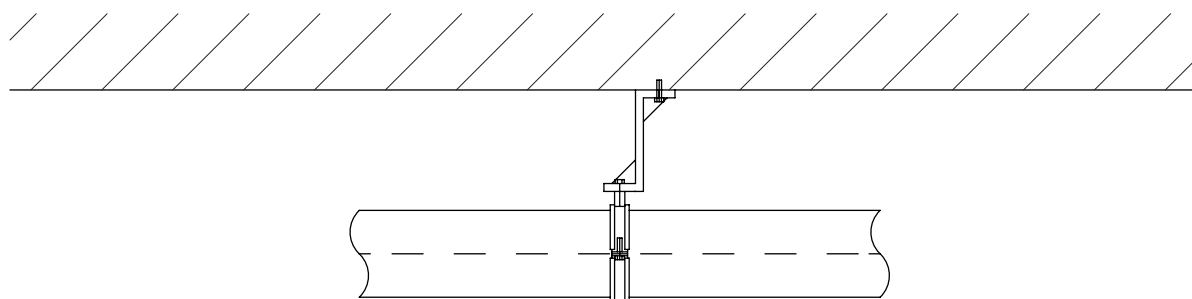

You can also use other types of support or profiles instead of cylindrical bars, above all when securing piping with a large diameter at a considerable distance from the anchor wall.

9.2.2.4 Examples of fixed-assembly installations

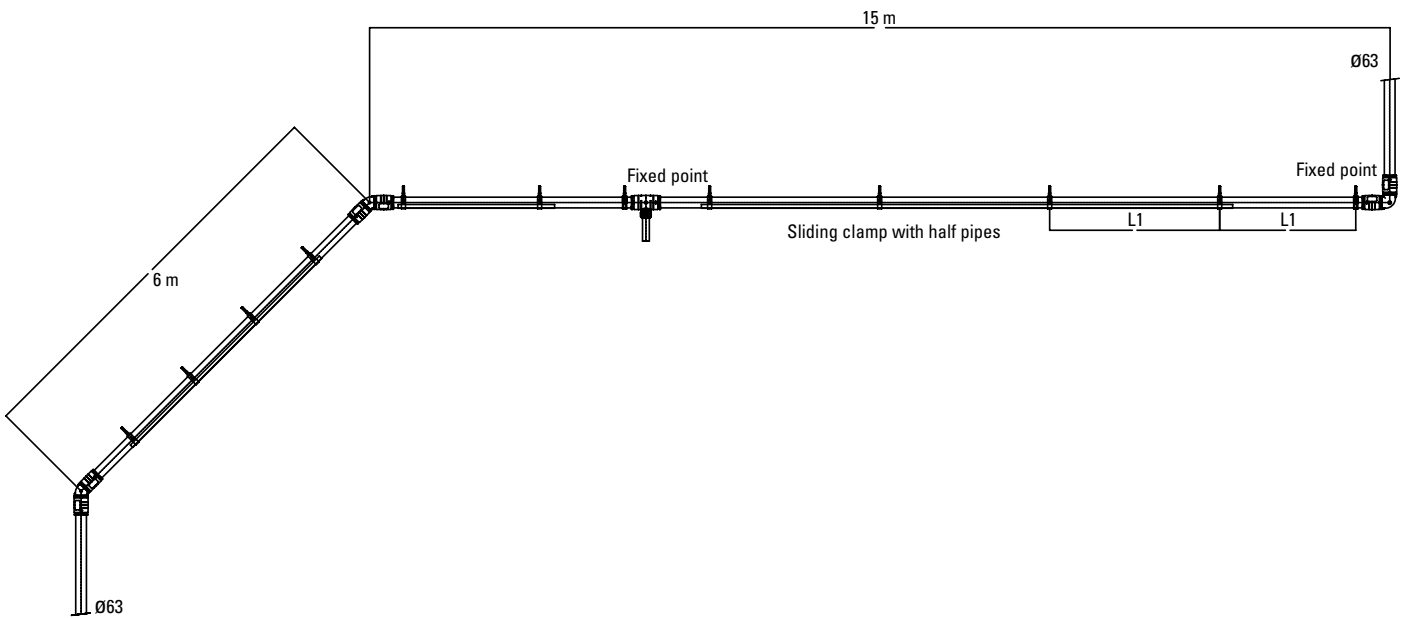
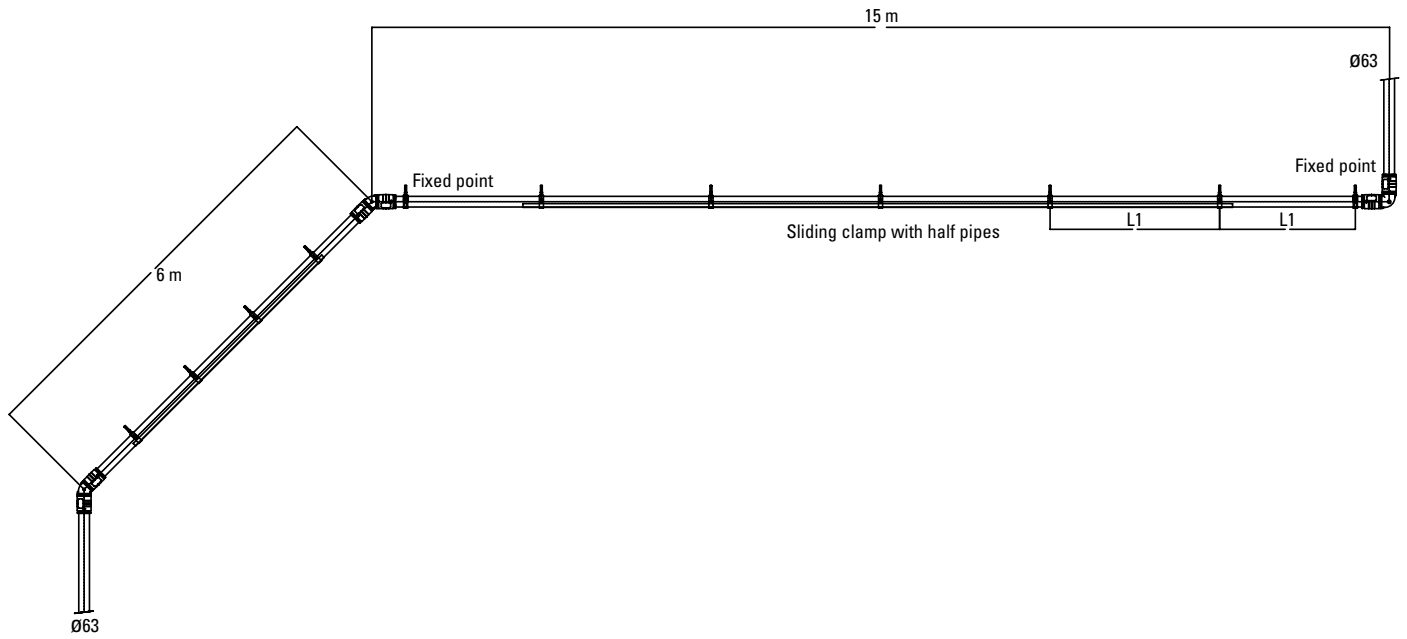



9.3. Selection of the installation procedure

The indications necessary to choose the recommended type of installation in each situation can be found below:

Matrix: Methods for controlling expansion/contraction

Type of installation	Expansion offsets and loops (without half pipes)	Expansion offsets and loops (without half pipes)	Without expansion offsets, without loops and without half pipes ("natural" half pipes)	Fixed assembly (always with half pipes)	On continuous supports (for example, cable trays)
	See 6,3/6,4	See 6,3/6,4	See 6,7	See 6,6	See 6,2
Horizontal					
Through false ceiling	✓ (≥ 75mm)	Not recommended	✓ (≤ 63mm)	Not recommended	✓
(visible)	✓ (≥ 75mm)	✓	Not recommended	✓ *)	✓
Vertical					
Uprights (<63 mm) with brackets	Not necessary**)	Not necessary**)	✓	✓ *)	
Uprights (>75 mm) with brackets	✓			✓ *)	
Uprights (visible)	✓ (≥ 75mm)	✓		✓ *)	

✓ =Ideal Application

*) The fixed points have to be well secured to the panels, walls or ceiling. The latter have to bear the forces of expansion/contraction. This system is ideal in cases where there is little space (without loops) and results in an aesthetic installation.

***) Due to the high flexibility of PB, the loops are "natural" for diameters up to 63 mm, as the pipe is allowed to bend between clamps between floors.

This matrix only shows typical installation systems.

For complex systems, please contact our technical team.

10. Types of installations and Terrain solutions

10. INSTALLATIONS

10.1. Line or traditional installations

10.2. Installation of distribution using manifolds (spider type)

10.3. Accessible installations (pipe-in-pipe)

10.4. Installations in plasterboard drywalls

10.5. Large diameters

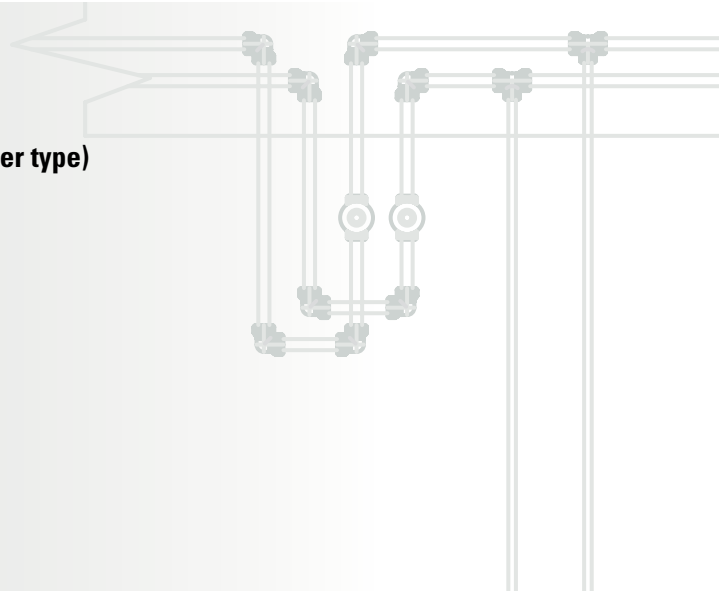



The advantages associated with the Terrain SDP piping system in polybutylene, in addition to being the optimum system in plumbing installations, allow the most diverse and modern distribution systems. Its high flexibility, the different joint methods and the complete catalogue by Nueva Terrain result in an extensive variety of possibilities and solutions.

10.1. Line or traditional installations

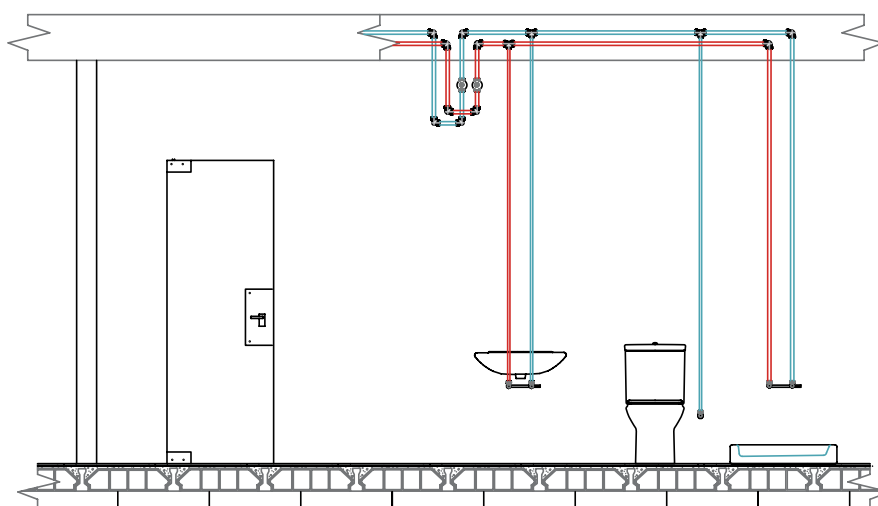

This is the traditional installation method, associated with and inherited from rigid piping systems. The distribution to the appliances of the wet room is done using individual Tees that derive to each one from the main pipe. It is a system with more joints and fittings, usually some are embedded, greater localised head loss and a poorer hydraulic balancing of the appliances. In general fewer metres of piping are used.

10.2. Installation of distribution using manifolds (spider type)

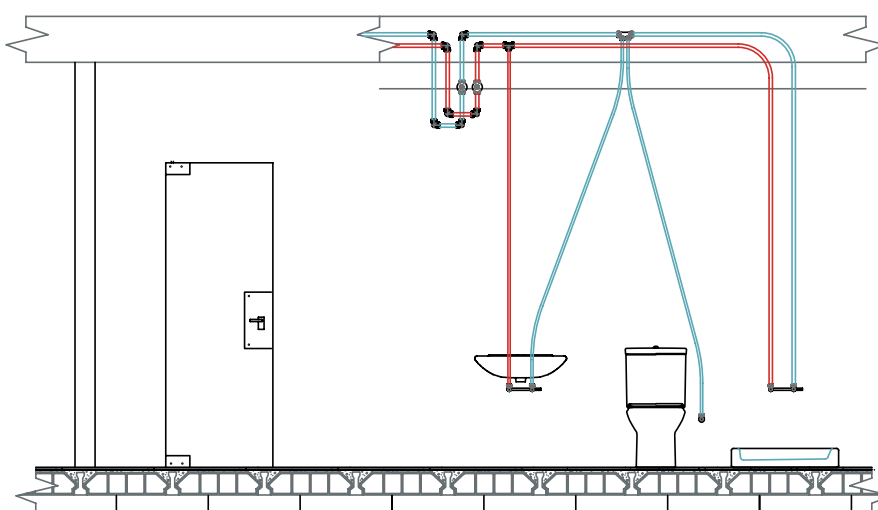

In this case the distribution to each appliance of the wet room is performed with a main manifold that is derived to a pipe at each of the appliances, taking advantage of the flexibility of PB piping.

It uses fewer joints and therefore it is quicker and has a lower head loss. The balancing of the flow to each appliance is optimum. It uses more metres of piping per installation, compensated by fewer fittings and joints.

10.3. Accessible installations (pipe-in-pipe)

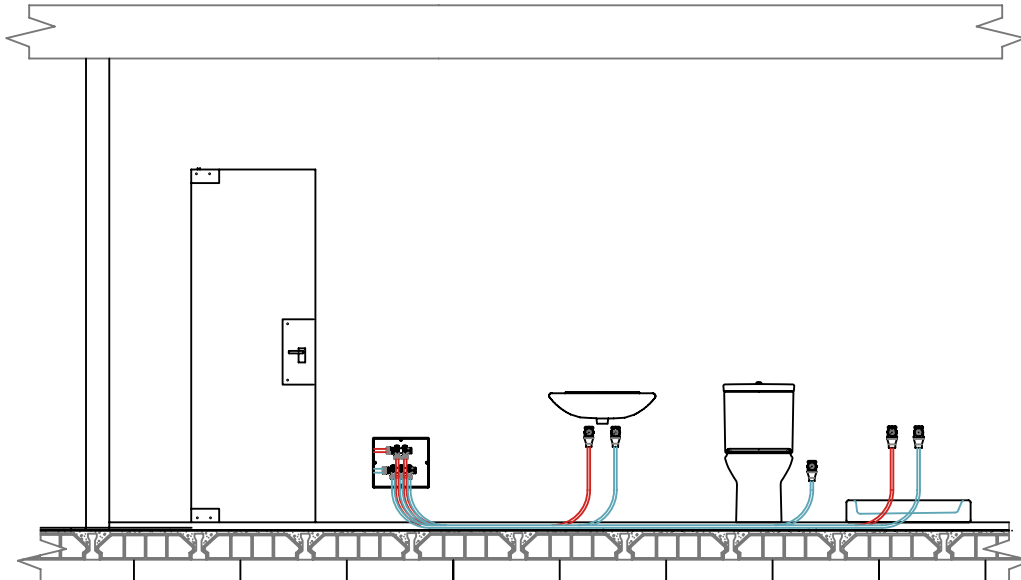

It is a variation of the previous system, with the advantage of having no hidden joints throughout the installation, so it is fully accessible. It consists of distribution using an accessible manifold, that derives sheathed PB pipes inside corrugated tubing to the threaded pipe joint of each appliance. This pipe joint has a specific design so the whole the pipe can be removed from the manifold to the appliance in the event of a fault or the need to replace it, any bricklaying work being necessary. It results in a system that is similar or equivalent to the electrical installation in the home.

Special fittings for pipe-in-pipe installations



The pipe can be removed without the need for construction work.



Recommendations for pipe-in-pipe installations

- Use the correct diameter of corrugated piping to ensure that the PB piping slides inside it. Nueva Terrain recommends these diameters:

Nominal diameter of the pipe (PB mm)	Corrugated conduit		
	External diameter (mm)	Internal diameter (mm)	Nominal diameter (mm)
15	28.5	22.5	23
16	28.5	22.5	23
20	34.4	28.5	29

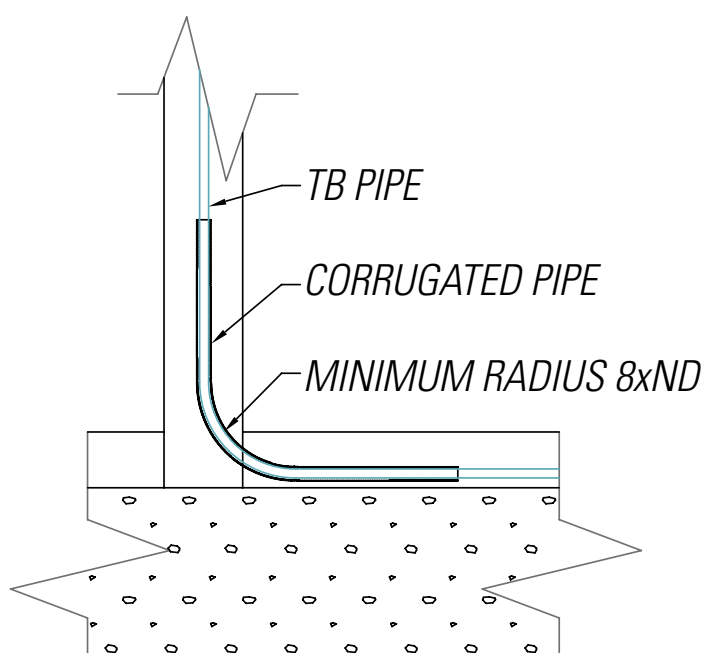

- Avoid small radii of curvature. Always try to make open curves to aid the insertion of the PB pipe into the corrugated tubing. The minimum recommended radii are 8xDN of the PB pipe
- Never insert fittings into the corrugated tubing. You must use uncut pipe from the manifold to the special external metal fitting.
- The manifolds must be installed in an accessible place.

10.4. Installations in plasterboard drywalls

The increasingly popular solution of drywalls for housing partitions has led to a demand for fixing systems from the point of entry to the property to the appliances and stopcocks for which there was no solution available on the market. Usually the anchoring solutions given were improvised and often failed, which wasted time and gave the sensation of moving taps. Nueva Terrain has designed an original and specific type of fixings that ensure the elements are anchored, reducing time and work, as well as resulting in optimum installations for use.

The specific fittings for plumbing installations in plasterboard panels are the following:

Supports for metal terminal elbows and for tap fixings.



Supports for shut-off ball valves.



Wall plug for securing pipes to plasterboard walls



Installation instructions

Support for metal elbow terminals and support for ball valves



1 Drill the plasterboard wall.



2 Insert the fitting to support the elbows.



3 Screw the tabs on.



There are two versions of the fitting for securing metal elbows:

1. FC.085 Fitting that enables installation from the front
2. FC.084 Fitting that must be bolted from the back

One of the two options will be chosen depending on the access to the working area.

Wall plug anchor for plasterboard.



1 Drill a hole of $\varnothing 6$ mm in the plasterboard and position the wall plug anchor.



2 Insert the clamp you are going to use.



3 Fasten the pipe to the clamp.

With this fitting, Nueva Terrain offers a solution for securing pipes in installations in plasterboard, making them cleaner, quicker and easier to install. It enables you to secure pipes up to $\varnothing 32$ mm. It is recommended to secure the pipe every 0.5 metres.

Advantages of these specific fittings

- Supports adaptable to different wall thicknesses
- Optimum securing of the elements (prevents the sensation of moving taps)
- Quick and simple installation, which saves time.
- Optimum presentation, which makes the subsequent tiling much easier.
- Supports valid for different diameters of fittings and pipes.

10.5. Large diameters

The Terrain SDP polybutylene system for large diameters is a unique solution in the range of piping systems available. It combines the excellent mechanical properties of the material with the most reliable connection system of the market, electrofusion at 40 V. This system ensures the supply of high-flow installations for which there is little available on the market due to the low working pressure of the other systems at high temperatures, or a lack of simple or specific joint systems for plastics in top-quality materials.

11. Thermal insulation for pipes

11. THERMAL INSULATION FOR PIPES

11.1. Recommendations for thermal insulation of piping





The objective of plumbing and heating installations is to supply water to a point in the home under defined conditions. Supply points must fulfil certain pressure, flow, purity and temperature parameters, therefore, the insulation of the piping system is essential to achieve a good supply.

Any fluid that circulates through a pipe exchanges heat with it, and this, in turn, exchanges heat with the environment. The amount of heat exchanged is generally expressed in Watts per metre of pipe (W/m), and depends on several factors:

- Temperature of the fluid
- External air temperature (external conditions in general)
- Flow transported
- Thermal conductivity of the pipe material and the insulation
- Diameter of the pipe and the insulation
- Pipe thickness and insulation layer

In most cases, it is necessary to thermally insulate the pipes to secure a good supply with minimum energy loss. For every installation, the thickness of the insulation that is necessary to meet the energy efficiency and supply quality requirements must be calculated.

In general, the calculations for heat transmission are complex, although there are an infinite number of computer applications that solve this kind of problem easily.

The construction standard sets out the guidelines regarding piping insulation. Thus, the RITE (Regulations for thermal installations in buildings) state the following in section IT 1.2.4.2..1.1 – General aspects:

- All pipes and fittings, as well as equipment, appliances and tanks in thermal installations shall have thermal insulation when containing fluids that have:
 - A lower temperature than the ambient temperature of the premises in which they are installed.
 - A temperature over 40°C, when installed in premises that are not heated, including corridors, galleries, ventilation courtyards, parking areas, equipment rooms, false ceilings and technical floors, excluding pipes in cooling towers and discharge pipes of refrigerating compressors, except when they are within the reach of people.

Point 6 of the same section indicates that:

- Throughout the thermal installation through which fluid circulates that is not subject to a change of state, in general the heat-carrying fluid is water, the global thermal losses in the piping system as a whole does not exceed 4% of the maximum power that it transports.

As a guide, the powers that different Nueva Terrain PB pipes are able to transport are shown below:

External D (mm)	Thickness (mm)	Internal D (mm)	Power (Kcal/h)	Power (KW)
15	1.7	11.6	7609	9
16	1.8	12.4	8695	10
20	2.3	15.4	13411	16
22	2.0	18.0	18321	21
25	2.3	20.4	23533	27
28	2.5	23.0	29913	35
32	2.9	26.2	38816	45
40	3.7	32.6	60096	70
50	4.6	40.8	94130	109
63	5.8	51.4	149395	173
75	6.8	61.4	213180	247
90	8.2	73.6	306313	354
110	10.0	90.0	458031	530
125	11.4	102.2	590624	683
160	14.6	130.8	967442	1119

Parameters used in the calculations:

- Fluid velocity (water): 1 m/s
- Thermal gap: 20°C

The velocity of the fluid can be increased up to 2 m/s, due to the low roughness of the plastic surfaces, which would increase the value of the power conducted.

11.1 Recommendations for thermal insulation of piping

• Hot water supply and heating:

- It is recommended to insulate all pipes that have a continuous circulation of fluid, such as heating and hot water supply recirculation circuits.
- It is not necessary to insulate the pipes with small diameters that do not have a continuous circulation of fluid, for example, domestic hot water supply pipes to the taps. This is possible because PB is a thermal insulator.

• Cold water supply:

- In general, it is recommended to insulate cold water piping to prevent it overheating to the point where legionella starts to breed. The possible thermal focusses that can affect the piping shall be taken into account.
- Regarding condensation, PB pipes do not suffer problems due to condensation, as PB is an insulator.

• Freezing:

- Due to the flexibility of PB, the pipes are able to elastically absorb the volume increase of the ice compared to that of the liquid water without breakage; in addition, the insulating nature of PB causes the water inside to lose less heat than it would in a metal pipe and, therefore, it is less likely to freeze.
- In this case, it is not possible to provide general recommendations, since everything depends on the climate of the area and the degree of exposure of the pipes. In each case the designer must decide whether to insulate the piping system or not, taking into account that, although the material may resist freezing without breakage, this disrupts the water supply, which in most cases is not acceptable. Therefore it is recommended to be conservative.



12. Chilled water application

12.1. Chilled water

12.1 Chilled water

Air conditioning systems require transportation of the coolant fluid from the “cold generation” source to the consumption point. Pipe and fitting system that allows this to happen are usually working under extreme conditions, like huge temperature differences, low temperature of the fluid and transport of corrosive fluid (coolant).

Polybutylene due to their outstanding mechanical and physical properties is a perfect material for this type of installation. Furthermore, the thermal insulation provided by the material itself helps reduce energy losses due to heat transfer.

The advantages of an installation with PB versus traditionally used metal pipes are listed below:

- Absolutely corrosion free (inside and outside of the pipe)
- No additional treatment required (eg- anti corrosion treatment of the pipe)
- Much less condensation on the pipe surface (PB is a thermal insulator material)
- Low thermal conductivity (0,22 w/mK) and therefore less energy loss
- Big temperature range of use, from - 15°C up to 95°C (for cooling and heating)
- Zero maintenance cost and long lifetime
- High chemical resistance (generally antifreezing or anticorrosion agents do not affect PB, brass or rubber joints)
- Very high pipe flexibility, which allows easy and comfortable installation especially when installed inside false ceilings and shafts.

- Low noise transmission due to of PB low E-modulus (450N/m²)
- Easy and safe jointing technologies available – PushFit and electrofusion –
- Less pressure drop due to the smooth pipe surface, and therefore less pump energy cost.
- Big range of fittings available, including adaptors or connectors to other piping systems, e.g. flange connections, screwed male/female connections from ½' up to 6" etc..
- Easy management of thermal expansion and contraction in the installation using "rigid fixing" method (only possible with PB pipes)
- High service pressure rate for cold water, which is PN 22 bar.

Formation of condensation:

Chilled water pipe installations carry a fluid (usually water with additives) which its temperature is always lower than the room temperature where they are installed. Typical temperature range for the supply pipe of chilled water piping is between 2 – 7°C (Fan coil units) or also 16-18°C for "radiant cooling" systems used on ceiling panels.

Depending on relative air humidity, this could produce water condensation on the external surface of the pipe, and cause damage.

Radiant cooling systems have not been widely applied because of the potential for condensate formation on the cold radiant surface of the pipes. Condensation caused by humidity is a limiting factor for the cooling capacity, the pipe surface temperature should not be equal or below the dew point temperature.

Plastic pipes have an advantage over the metallic ones, they have a low thermal conductivity, and therefore the surface temperature will be warmer than the metallic pipes so the condensation will be reduced or disappear (depending on the ambient conditions).

For example, copper has a thermal conductivity of about 407 w/m K while PB only has 0.22 w/m K.

Anyhow, Nueva Terrain always recommends to insulate the chilled water pipes which are supplying the cold fluid to the Fan Coil Units or to the ceiling panels. The reasons are:

- + Avoiding condensation
- + Reducing energy losses.

Considering the calculations made with standard conditions as:

- Fluid temperature : 5°C
- Room air temperature: 28°C
- Relative air humidity: 60%
- Type of insulation: soft rubber with λ value 0.035W/mK
- Fluid velocity in the PB pipe (0.5m/s)

An **insulation thickness of 6mm** would be enough to avoid condensation on PB external surface.

Therefore a 13mm insulation thickness, which is often a standard thickness, is an ideal compromise as it also has enough thickness to safe energy cost.

It is important that the insulation in cold water pipes is made with closed-cell fabric with a low water vapour transmission, otherwise the insulation will get wet and useless.



Calculation of the dew point temperature

The dew point is the temperature at which the water vapour from the air start to condensate into liquid water. When there is a solid objet which its temperature is below the dew point then starts the formation of dew on its surface.

Dew point temperature can be estimated knowing the relative Air humidity and the air temperature. So, comparing the dew point temperature with the pipe surface temperature you can know if there will be water condensation or not.

To obtain a precise value of the dew point temperature, you must use a H-S Mollier diagram, but there are empirical equations to calculate it approximately:

To estimate the dew point temperature, this empirical equation can be used:

$$D_p = \left(\frac{RH}{100} \right)^{\frac{1}{8}} * (112 + 0,9 T) + 0,1 T - 111.965$$

Where:

D_p = dew point temperature (°C)

RH = relative humidity (%)

T = air temperature (°C)

There is a reduced equation very easy to handle that works only when the relative humidity is above 50%:

$$D_p = T - \left(\frac{100 - RH}{5} \right)$$

Calculation of pipe surface temperature:

Once you know the dew point temperature, you should compare it with the pipe surface temperature to determine if there will be condensation or not.

This can be calculated with the below basic formula:

$$Q = \frac{2 * \pi * l * (t_1 - t_2)}{\frac{\ln r_2}{r_1} + \frac{l}{a_k * r_2}}$$

$$t_2 = \frac{Q * \frac{\ln r_2}{r_1}}{2 * \pi * l * \lambda} + t_1$$

Where:

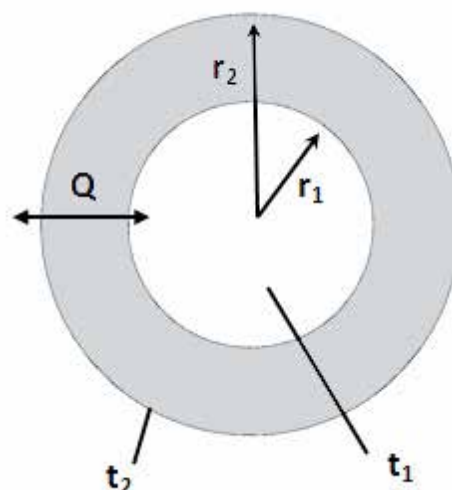

Q = heat energy transmitted through pipe (W/m)

l = length of pipe (m)

t_1 = water temperature (°C)

t_2 = pipe outer surface temperature (°C)

t_a = ambient air temperature (°C)

α_k = heat transfer coefficient (w/m² K)

λ = thermal coefficient of pipe material (w/m k)

r_1 = inner pipe radius (m)

r_2 = outer pipe radius (m)

Comparison between materials:

Criteria	PB pipe		Steel pipe		Copper pipe	
Thermal conductivity λ (w/mK)	0.22		52		407	
Ext. heat transfer coeffi α_k (w/m ² K)	25		25		25	
Ambient air temperature (°C)	25		25		25	
Water temperature (°C)	15	65	15	65	15	65
Pipe diameter	25 x 2.3 mm		26.9x2.65mm		22x1.5mm	
Outer pipe surface temp. (°C)	17	56	15	65	15	65

Example of calculation

Given project data:

- Pipe characteristics: PB pipe D25x2.3 mm
- Ambient air temperature: 25°C
- Relative air humidity: 60%
- Fluid temperature: 15°C

First calculate the outer pipe temperature:

$$Q = \frac{2 * \pi * l * (t_1 - t_2)}{\frac{\ln r_2}{\lambda} + \frac{l}{\alpha_k * r_2}} = \frac{2 * \pi * l * (15 - 25)}{\frac{\ln 0.0125}{0.22} + \frac{1}{25 * 0.0125}} = -15,23 \left(\frac{W}{m} \right)$$

$$t_2 = \frac{Q * \frac{\ln r_2}{r_1}}{2 * \pi * l * \lambda} + t_1 = \frac{Q * \frac{\ln 0.0125}{0.0102}}{2 * \pi * 1 * 0,22} + 15 = 17,24 \text{ } ^\circ\text{C}$$

Note that Q is a negative value, this indicates that “energy is flowing” into the pipe.



Now we calculate the dew point temperature:

$$D_p = \left(\frac{RH}{100} \right)^{\frac{1}{8}} * (112 + 0,9 T) + 0,1 T - 111.965 = \left(\frac{60}{100} \right)^{\frac{1}{8}} * (112 + 0,9 25) + 0,1 25 - 111.965 = 16.7^{\circ}\text{C}$$

Due to the pipe surface temperature is higher than the dew point temperature, no condensation will occur.

See "comparison between material" table to check that under these same conditions a steel pipe or copper pipe will have problems of condensation.

13. QUALITY control

13. QUALITY CONTROL

13.1. AENOR Certification for PB pipes

13.2. AENOR Certification for PB fittings

13.3. AENOR Certification for the complete PB system

13.4 Kiwa certification

13.5. Nueva Terrain laboratory and workshop

13.6. List of applicable standards and legislation

Since we started out, the main aim of Terrain has always been to offer our customers a different product to those that can be found on the market: versatile, with a flexible response to the problems of each particular installation, lasting, functional and satisfactory for the installer and the end users of our products.





While the words “standard” and “quality” were strange concepts for the customers of the Spanish market, at Terrain we were already using them as guidelines for achieving our goal.

To obtain quality products, it is not enough to simply declare this quality, there must also be a reference template. This reference template, which establishes the requirements that the products must meet, is the standard. The compliance with these requirements establishes the quality, but the maximum guarantee that a customer may have is that an independent body certifies this compliance.

Terrain, in its ongoing development of products, processes and controls, is continuously preparing for the future.

From the start of the preparation of the European standards it participated in the international standardisation forums.

This meant we knew from day one what the requirements that Europe was considering were and could adapt all of our products to comply with the current Spanish standard.

13.1. AENOR Certification for PB pipes

PB pipes manufactured by Terrain meet the international standard UNE-EN ISO 15876. Such compliance is not only guaranteed by Nueva Terrain, but also by AENOR, an independent certification and standardisation body. Some other certification bodies might require the standard DIN16969/16968 or BS7291-1&2. However, our piping system meet all here mentioned standards.

To achieve and guarantee this quality standard, Terrain has developed a control plan, divided into three broad areas: a control of the raw material or reception, a control during the manufacturing process and a final control of the finished product.

- All the raw materials are received identified by batch, with the corresponding quality certificate for each batch issued by the manufacturer. Before proceeding to its mass consumption, each batch received is subjected to tests, such as melt flow index (MFI), transformation and characteristics of the end product.

- During the manufacturing process, and, in addition to a control and recording of the manufacture parameters, an exhaustive dimensional control of the pipe is also performed, which includes:

- Continuous control, using laser techniques, of the minimum, maximum and average diameters.
- Control and recording of these diameters every hour during manufacture.
- Control and recording of the minimum and maximum thicknesses every hour during manufacture.
- Control and recording of lengths, appearance and marking conformity every hour during manufacture.

- Subsequent to the manufacturing process, and when the crystallisation of the material has occurred, the same controlled samples during manufacture are measured and recorded. This control is performed by different personnel from those who performed it in the manufacturing process.

- The following tests are carried out daily: heat performance behaviour tests, internal pressure tests at 20°C for one hour and at 95°C for 22 hours.

After the strict completion of the steps mentioned above, if the results comply with the standard, the manufactured product can proceed to workshop. This control is performed and supervised by personnel with no links to the manufacturing department answering exclusively to the company management.

With the purpose of properly guaranteeing the quality levels, we also carry out internal pressure tests at 95°C for 170 hours and 1000 hours and for 8760 hours at 110°C. These tests take place continually throughout the year.

The majority of the controls indicated are made with a frequency and strictness that is much higher than that indicated by the certification body itself, AENOR.

13.2. AENOR Certification for PB fittings

All PB fittings manufactured by Terrain meet the Spanish standard UNE-EN ISO 15876. As with the pipes, this compliance is not only guaranteed by Nueva Terrain but also by AENOR. For this reason, we undergo auditing of the quality system and regular checks of all fittings, carried out by AENOR technical services. All this allows Terrain to mark its fittings with the Spanish quality standard .

To achieve and guarantee this quality standard, Terrain has developed a control plan, divided into three broad areas: a control of the raw material, a control during the manufacturing process and a final control of the finished product.

- All the raw materials are received identified by batch, with the corresponding quality certificate for each batch issued by the manufacturer. Before proceeding to its mass consumption, each batch received is subjected to tests, such as melt flow index (MFI), processability and characteristics of the end product.
- During the manufacturing process and, in addition to a control and record of the production parameters, a strict control of weights is also performed.



- Selected samples of each cavity are taken every eight hours after the manufacturing process, which undertakes a daily dimensional control of more than 100 units. This control is performed by different personnel than those who performed it during the manufacturing process, with measuring techniques using coordinates.
- Internal pressure tests at 20°C for one hour and at 95°C for 22 hours are performed daily.

After the strict completion of the steps mentioned above, if the results comply with the standard, the manufactured product can proceed to assembly.

This control is performed and supervised by personnel with no links to the manufacturing department answering exclusively to the company management.

- With the purpose of properly guaranteeing the quality levels, we also carry out internal pressure tests at 95°C for 170 hours and 1000 hours. These tests take place continually throughout the year.

The controls indicated are made with a frequency and strictness that is much higher than that indicated by the certification body itself, AENOR.

13.3. AENOR Certification for the complete PB system

As we have already indicated in section 4, high performance pipes and fittings connected using unreliable joint systems result in installations that have no future. The guarantee of the reliability of our joint systems is again endorsed by AENOR, since our system meets the requirements of the standard UNE-EN ISO 15876.

the joints of our system are subjected to the following tests, both in-house and by independent laboratories selected by AENOR:

- Resistance to internal pressure at 20°C for one hour, at 95°C for 22 hours, 170 hours and 1000 hours, and at 110°C for 8760 hours.
- Pull-off tests at a constant load at 23°C and 90°C.
- Tightness of the under curvature of the tubes.
- Tightness of the joints in thermal cycles lasting more than three months.
- Tightness of the joints in pressure cycles.
- Tightness of the joints with an interior vacuum.

This control is performed and supervised by external personnel answering exclusively to the company management, and is conducted not only with a greater frequency than those indicated by the certification body, AENOR, but with stricter requirements also.

The reliability of the joint is confirmed by numerous tests performed on the joint system, performed in laboratories of both Terrain and other independent organisations, as well as various certifications,...

As well as the above, complementary testing is performed to reinforce the safety of the joint as the most important and critical part of the system. Examples of this reliability include:

1. In all internal pressure tests that are performed on pipes joined to fittings, from 20°C to 95°C, the ruptures caused always occur in the pipe or in the body of the fitting but never in the joint between them. Our joint is always more resistant than the elements joined, and the rupture pressure of the joint can never be reached without first reaching that of the pipe or fitting. Therefore the final installation carried out with our joint system maintains the performance that PB offers as a material.

2. To give you an idea of the resistance of the grab ring joints, one of the quality control tests is explained below: the pull-out test. This test, included in the standard UNE-EN ISO 15876, consists of subjecting the joint between the pipe and fitting to a pulling force determined for each diameter for 1 hour at a temperature of 20°C without the joint coming apart. This force may simply consist of a weight hanging from the joint being tested. This standard requires forces that the joints must be able to withstand, but Terrain, which has been performing this test for a long time even before the preparation of the standard had even begun, subjects their joints to forces greater than those required.

For example:

NOMINAL DIMENSIONS	FORCE (KG) REQUIRED BY UNE-EN ISO 15876"	FORCE (kg) USED BY TERRAIN IN TESTING
(1) 15 x 1.8	27	81
(2) 16 x 1.8	31	93
(3) 20 x 1.9	48	126
(4) 22 x 2.4	58	170
(5) 25 x 2.3	75	191
(6) 28 x 2.8	94	258
(7) 32 x 2.9	123	308
(8) 40 x 3.7	128	490
(9) 50 x 4.6	200	763

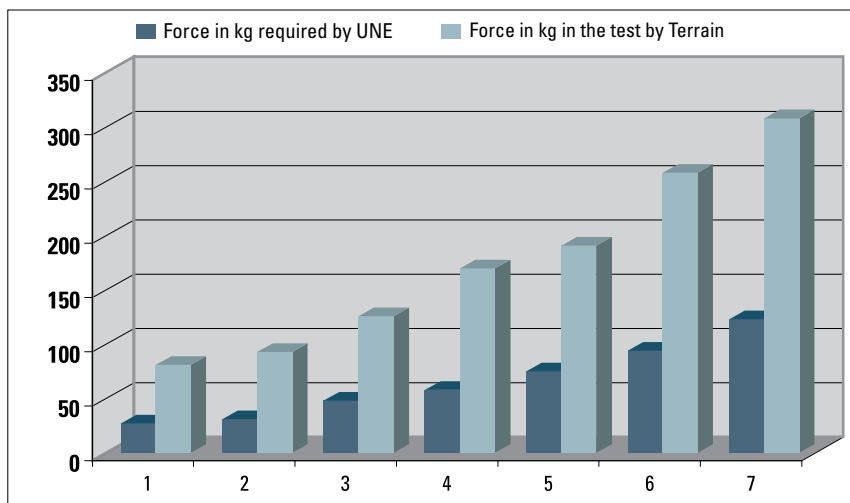



As can be verified, Terrain tests its system with requirements approximately three times those considered in the standard UNE-EN ISO 15876.

3. We have to bear in mind that in a real installation the pressure is not constant, and the pipes “suffer” movements caused by expansion and contraction and overpressures occur due to water hammer. An internal pressure test is always carried out at a constant pressure and temperature, and, therefore, does not take into account the multiple situations that can occur in a real installation. With the purpose of simulating all of these events Terrain has been subjecting its joint system to controlled water hammer for more than 10 years.

At variable temperatures between 20°C and 45°C water is circulated at a pressure of 7 bar for 3 seconds, then at a pressure of 0 bar for 2 seconds and the cycle is started again with 7 bar. The changes in pressure are instantaneous, enabling the free movement of some joints and restricting it in others. For example, pipes, fittings and joints have been subjected to more than 10 million cycles in the indicated conditions, which entails more than 13,000 hours of testing and more than 20 million instances of water hammer without any impact on our joint system. (By way of anecdotal evidence we could indicate that during the trial 3 pressure gauges and 2 electrovalves broke due to the severity of the test).

13.4 - Kiwa certification

Kiwa is an independent organization dedicated to the certification of products according to a set of standards developed by itself. Its high level of demand has led to the international recognition of their certifications for piping systems to supply drinking water (Kiwa-ATA) and for pipes dedicated to heating and underfloor heating. (KOMO)

Nueva Terrain has the KIWA-ATA certification for pipes, fittings and jointing system, which involves meeting the high demands of its standards and pass extensive testing to ensure reliable operation of the system and its validity for transporting drinking water.

Nueva Terrain also has the KOMO certification for multilayer pipes intended for high temperature heating and underfloor heating.

Not only the product must meet the required demands, Kiwa also requires implementing a strict quality control at the company to ensure that manufacturing processes are done correctly over time.

Hygienically perfect

The evaluation of the health related aspects of materials in contact with drinking water is, in general, part of a comprehensive evaluation of that material with regard to technical and other aspects. This comprehensive evaluation is detailed in an evaluation guideline (Kiwa BRL) that applies to the product.

13.5. Nueva Terrain laboratory and workshop

At Nueva Terrain we have our own laboratory where we perform all of the aforementioned tests, with specific staff independent of the production department, performing the manufacture release test and research and development testing of new products that update our catalogue continually.

The availability of this laboratory, equipped to a level comparable to the best specific laboratories in the sector, as well as the integration within the company of our own metal workshop for the construction and maintenance of the moulds and tools for manufacture, ensures our products meet the maximum level of quality on the market, which without doubt benefits our end customers.

13.6. List of applicable standards and legislation

UNE-EN ISO 15876: Plastics piping systems for hot and cold water installations. Polybutylene (PB).

UNE-EN 12165: Copper and copper alloys. Wrought and unwrought forging stock.

UNE-EN 805: Water supply. Requirements for systems and components outside buildings.

UNE-EN 806: Specifications for installations inside buildings conveying water for human consumption.

UNE-EN 1264: Floor heating. Systems and components.

UNE-CEN/TR 12108: Plastics piping systems. Guidance for the installation inside buildings of pressure piping systems for hot and cold water intended for human consumption.

UNE 53389 IN: Plastics pipes and fittings. Combined chemical-resistance classification table.

UNE 53959 IN: Plastics. Thermoplastics pipes and fittings for the transport of liquids under pressure. Calculation of head losses.

UNE 149201: Water supply. Sizing of installations inside buildings conveying water.

UNE-EN ISO 15494: Plastics piping systems for industrial applications. Polybutylene (PB), Polyethylene (PE) and Polypropylene (PP). Specifications for components and the system.

Product Certification - AENOR product marking

The AENOR marking  is a sign of conformity with the corresponding standard production. It certifies that the products that receive it have passed the assessments and controls that are established in the certification systems, thus guaranteeing the user a quality product.

“AENOR is a constituent member of the CEN (European Committee for Standardisation) that groups the national standardisation bodies of more than 30 European countries. It is therefore an internationally recognised, prestigious marking due to its demands and presence on the market.”

Legislation

International standards listed in the previous section are not mandatory. In each country there is legislation that must be met before installing pipe and fittings for drinking water supply and heating.

Usually international standards are more restrictive than national legislations which is why manufacturers are certified according to these standards and thus ensure the conformity of the product.



Annexes:

Annex 1: Polybutylene regression curve

Annex 2: Regression curves of various materials at 80°C

Annex 3: Miner's rule

Annex 4: Calculation of stress design for class 2 in PB pipes

Annex 5: Head loss in PB pipes according to international standard ISO/TR 10501

Annex 6: Graph for the calculation of expansion in PB pipes

Annex 7: Graph for determining the expansion force in PB pipes

Annex 8: Table of PB resistance to chemical agents

Annex 9: Sum-Up of TENDER specification according TERRAIN SDP

Annex 10: Hot water expulsion time

Annex 1: Polybutylene regression curve

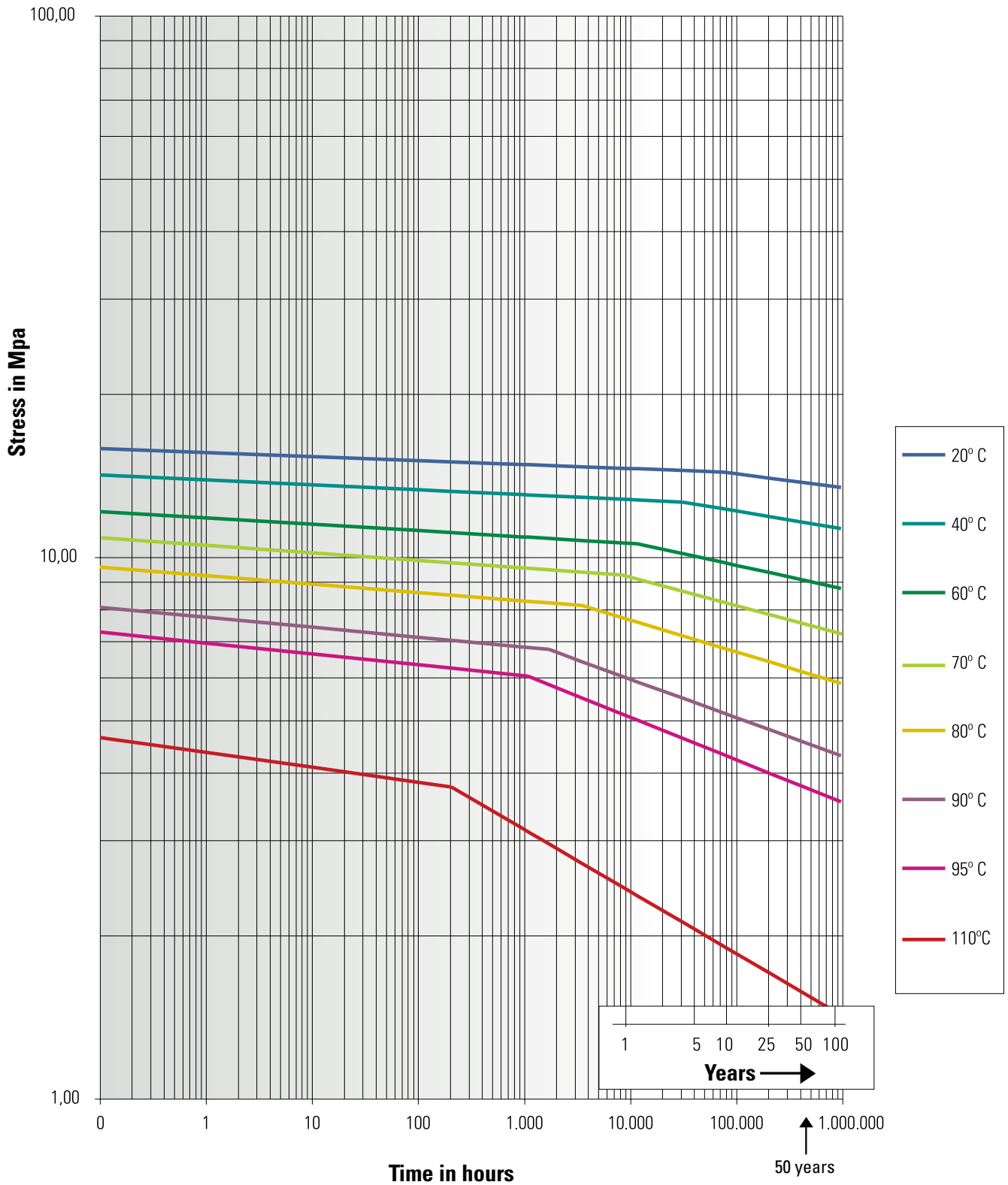



Annex 2: Regression curves of various materials at 80°C

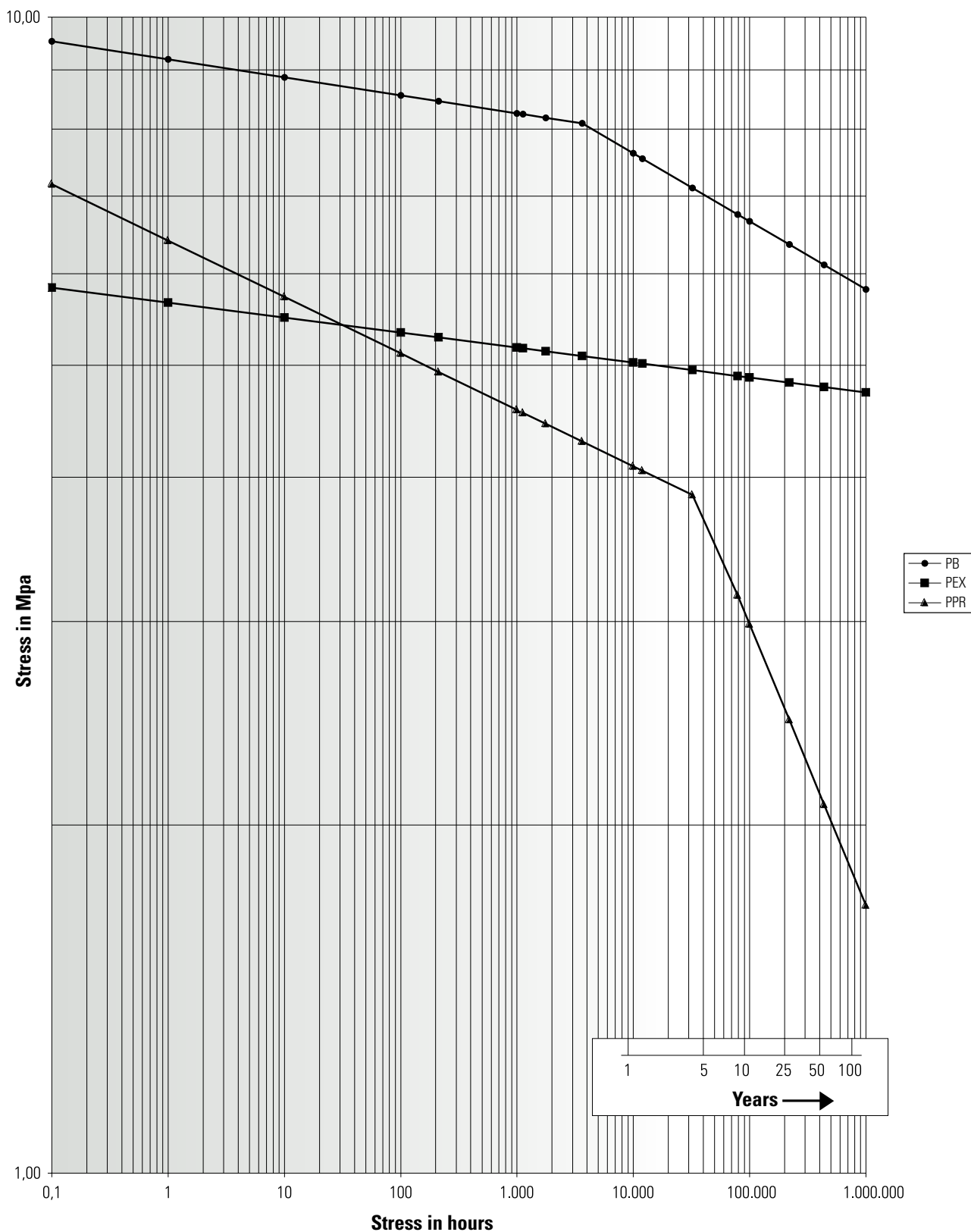

Annex 3: Miner's rule

The method for calculating the maximum permissible stress on a pipe exposed to variations in pressure and temperature throughout its lifetime is known as Miner's rule.

It is a "cumulative damage" method, standardised in ISO 13760.

The method is based on the following premises:

- The total damage that a material (in this case, a pipe) can suffer during a certain time under constant attack (100%).
- Under constant conditions, the damage produced is proportional to the duration of the attack. The material will resist until 100% of the damage level is reached. If we call this time t_i (in years) the amount of damage caused for each year is $100\% / t_i$. This premise is none other than a proportionality rule.
- If the material is exposed to damage conditions for only part of the year (for example a $a_i\%$ of the year, instead of 100% of the year) the annual damage will not be $100\% / t_i$, but $a_i\% / t_i$.
- With damage of the same nature but in variable conditions (different pressures, temperatures, etc.), one after the other, the total amount of annual damage is the combined effect of the variable conditions. The rule of addition presumes that the individual amounts of damage can be added. This result is none other than the accumulated damage under variable conditions.

In accordance with the above, the total damage per year will be $\sum a_i / t_i$, expressed as a percentage of the total damage permitted. Once this figure has been obtained the maximum lifetime or useful life is calculated as $100 / \text{TDY}$, in years.

Annex 4: Calculation of stress design for class 2 in PB pipes

The class 2 working conditions are:

- 49 years (out of a total of 50) at 70°C, in other words, 98 % of its total lifetime.
- 1 year (out of a total of 50) at 80°C, in other words, 2% of its total lifetime.
- 100 hours (out of a total of 50 years) at 95°C, in other words, 0.0228% of its total lifetime.

Proceed as follows:

- Start by taking an initial calculation stress, for example 5 Mpa.



- The working coefficients of the materials shall be applied to this stress:

TEMPERATURE	WORKING COEFFICIENTS	STRESS
Top = 70°C	1.5	5 x 1.5 = 7.5
Tmax = 80°C	1.3	5 x 1.3 = 6.5
Tmal = 95°C	1.0	5 x 1.0 = 5.0

- The lifetime is calculated for each of these stresses, either on the regression curve graph or, better still, in order to carry out repeated calculations, in the equations of these curves:

STRESS	LIFETIME
7.5	5.5 x 10 ⁵
6.5	1.4 x 10 ⁵
5.0	10.5 x 10 ³

- The percentage of use is applied to each of these lifetimes:

STRESS	a i / t i
7.5	1.8 x 10 ⁴
6.5	1.4 x 10 ⁵
5.0	2.2 x 10 ⁶

- The TDY value is calculated as the sum of all previous results:

$$TDY = 1.9 \times 10^{-4}$$

- Finally, the lifetime for a supposed stress value of 5.0 Mpa is calculated:

$$t = 100 / 1.9 \times 10^{-4} = 526316 \text{ hours} = 60 \text{ years.}$$

- Since the result is above the stress design specification for 50 years of use, it must be recalculated taking a slightly higher stress value. If the result is under 50 years, the new calculation shall be done with a higher stress value.

Thus, for example, if we do the calculation with a stress design value of 5.1 Mpa, the resulting lifetime is 40 years. By repeated calculations, the value indicated in chapter 5.3 for a stress design of 5.04 Mpa is reached, for which the resulting lifetime is 50 years, as was the objective.

Annex 5: Head loss in PB pipes according to international standard ISO/TR 10501

Head loss in PB pipes according to Colebrook (K value = 0.0015)

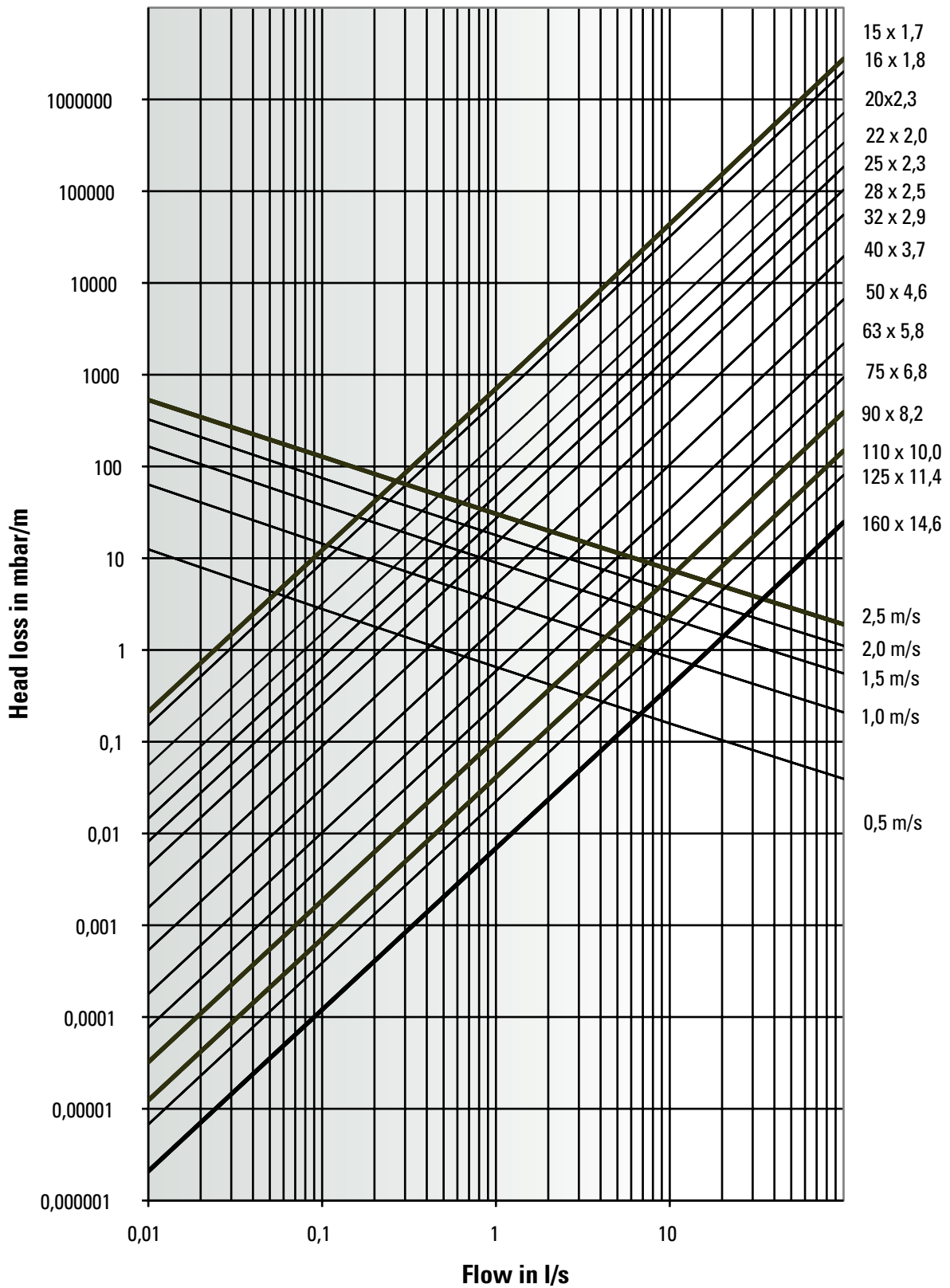



Head loss in PB pipes according to international standard ISO/TR 10501

Units:	ΔP : mbar/m		v: m/s							
De (mm)	15		22		25		28		32	
e (mm)	1.7		2		2.3		2.5		2.9	
Di (mm)	11.6		18		20.4		23		26.2	
V (l/m)	0.11		0.25		0.33		0.42		0.54	
Q (l/s)	ΔP	v	ΔP	v	ΔP	v	ΔP	v	ΔP	v
0.05	3.61	0.47								
0.06	4.98	0.57								
0.07	6.53	0.66								
0.08	8.26	0.76	1.02	0.31	0.56	0.24				
0.09	10.17	0.85	1.26	0.35	0.69	0.28	0.39	0.22		
0.1	12.24	0.95	1.51	0.39	0.83	0.31	0.47	0.24		
0.15	24.99	1.42	3.09	0.59	1.70	0.46	0.96	0.36	0.52	0.28
0.2	41.46	1.89	5.12	0.79	2.82	0.61	1.59	0.48	0.86	0.37
0.25	61.40	2.37	7.58	0.98	4.18	0.76	2.36	0.60	1.27	0.46
0.3	84.63	2.84	10.45	1.18	5.76	0.92	3.25	0.72	1.75	0.56
0.35	111.01	3.31	13.71	1.38	7.56	1.07	4.27	0.84	2.30	0.65
0.4	140.42	3.78	17.34	1.57	9.56	1.22	5.40	0.96	2.90	0.74
0.45	172.76	4.26	21.34	1.77	11.76	1.38	6.64	1.08	3.57	0.83
0.5	207.96	4.73	25.69	1.96	14.16	1.53	8.00	1.20	4.30	0.93
0.6	286.64	5.68	35.41	2.36	19.51	1.84	11.02	1.44	5.93	1.11
0.7	375.98	6.62	46.44	2.75	25.59	2.14	14.46	1.68	7.78	1.30
0.8			58.74	3.14	32.38	2.45	18.29	1.93	9.84	1.48
0.9			72.27	3.54	39.83	2.75	22.50	2.17	12.11	1.67
1			87.00	3.93	47.95	3.06	27.09	2.41	14.57	1.85
1.1			102.89	4.32	56.71	3.37	32.04	2.65	17.23	2.04
1.2			119.92	4.72	66.09	3.67	37.34	2.89	20.08	2.23
1.3			138.06	5.11	76.09	3.98	42.99	3.13	23.12	2.41
1.4			157.29	5.50	86.69	4.28	48.98	3.37	26.34	2.60
1.5			177.60	5.89	97.88	4.59	55.30	3.61	29.75	2.78
1.6			198.96	6.29	109.65	4.90	61.95	3.85	33.32	2.97
1.7			221.37	6.68	122.00	5.20	68.93	4.09	37.08	3.15
1.8					134.91	5.51	76.22	4.33	41.00	3.34
1.9					148.38	5.81	83.83	4.57	45.09	3.52
2					162.40	6.12	91.75	4.81	49.35	3.71
2.2					192.06	6.73	108.51	5.30	58.37	4.08
2.4							126.46	5.78	68.03	4.45
2.6							145.59	6.26	78.32	4.82
2.8							165.88	6.74	89.23	5.19
3							187.29	7.22	100.75	5.56
3.2							209.82	7.70	112.87	5.94
3.4							235.44	8.18	125.58	6.31
3.6							260.96	8.66	138.87	6.68

De → External pipe diameter (mm)
e → Pipe thickness (mm)
Di → Internal pipe diameter (mm)
V → Internal volume per metre of pipe (l/m)

Q → Flow (l/s)
 ΔP → Head loss per metre (mbar/m)
v → Water circulation velocity (m/s)

Head loss in PB pipes according to international standard ISO/TR 10501

Units:		ΔP : mbar/m		v: m/s							
De (mm)		16		20		25		32		40	
e (mm)		1.8		2.3		2.3		2.9		3.7	
Di (mm)		12.4		15.4		20.4		26.2		32.6	
V (l/m)		0.12		0.19		0.33		0.54		0.83	
Q (l/s)		ΔP	v	ΔP	v	ΔP	v	ΔP	v	ΔP	v
0.05		2.63	0.41								
0.06		3.63	0.50	1.29	0.32						
0.07		4.76	0.58	1.70	0.38						
0.08		6.02	0.66	2.15	0.43	0.56	0.24				
0.09		7.40	0.75	2.64	0.48	0.69	0.28				
0.1		8.91	0.83	3.18	0.54	0.83	0.31				
0.15		18.19	1.24	6.49	0.81	1.70	0.46	0.517	0.28	0.183	0.18
0.2		30.18	1.66	10.76	1.07	2.82	0.61	0.858	0.37	0.303	0.24
0.25		44.70	2.07	15.94	1.34	4.18	0.76	1.270	0.46	0.449	0.30
0.3		61.61	2.48	21.97	1.61	5.76	0.92	1.751	0.56	0.619	0.36
0.35		80.81	2.90	28.81	1.88	7.56	1.07	2.296	0.65	0.811	0.42
0.4		102.22	3.31	36.45	2.15	9.56	1.22	2.905	0.74	1.026	0.48
0.45		125.77	3.73	44.84	2.42	11.76	1.38	3.574	0.83	1.263	0.54
0.5		151.40	4.14	53.98	2.68	14.16	1.53	4.302	0.93	1.520	0.60
0.6		208.68	4.97	74.40	3.22	19.51	1.84	5.930	1.11	2.095	0.72
0.7		273.72	5.80	97.59	3.76	25.59	2.14	7.778	1.30	2.748	0.84
0.8		346.23	6.62	123.44	4.29	32.38	2.45	9.839	1.48	3.476	0.96
0.9				151.87	4.83	39.83	2.75	12.105	1.67	4.277	1.08
1				182.82	5.37	47.95	3.06	14.571	1.85	5.149	1.20
1.1				216.21	5.91	56.71	3.37	17.233	2.04	6.089	1.32
1.2				251.99	6.44	66.09	3.67	20.084	2.23	7.097	1.44
1.3				290.11	6.98	76.09	3.98	23.123	2.41	8.170	1.56
1.4						86.69	4.28	26.344	2.60	9.309	1.68
1.5						97.88	4.59	29.746	2.78	10.510	1.80
1.6						109.65	4.90	33.324	2.97	11.775	1.92
1.7						122.00	5.20	37.076	3.15	13.101	2.04
1.8						134.91	5.51	41.000	3.34	14.487	2.16
1.9						148.38	5.81	45.093	3.52	15.933	2.28
2						162.40	6.12	49.353	3.71	17.439	2.40
2.2						192.06	6.73	58.367	4.08	20.624	2.64
2.4								68.026	4.45	24.037	2.88
2.6								78.317	4.82	27.673	3.11
2.8								89.228	5.19	31.528	3.35
3								100.748	5.56	35.599	3.59
3.2								112.867	5.94	39.881	3.83
3.4								125.575	6.31	44.371	4.07
3.6								138.865	6.68	49.067	4.31
3.8										53.966	4.55
4										59.064	4.79
4.2										64.360	5.03
4.4										69.852	5.27
4.6										75.536	5.51
4.8										82.093	5.75
5										88.352	5.99
5.5										104.888	6.59

De → External pipe diameter (mm)

e → Pipe thickness (mm)

Di → Internal pipe diameter (mm)

V → Internal volume per metre of pipe (l/m)

Q → Flow (l/s)

ΔP → Head loss per metre (mbar/m)

v → Water circulation velocity (m/s)



Head loss in PB pipes according to international standard ISO/TR 10501

Units: ΔP : mbar/m v : m/s

De (mm)	16		20		25		32		40	
e (mm)	2.2		2.3		2.3		2.9		3.7	
Di (mm)	11.6		15.4		20.4		26.2		32.6	
V (l/m)	0.11		0.19		0.33		0.54		0.83	
Q (l/s)	ΔP	v	ΔP	v	ΔP	v	ΔP	v	ΔP	v
0.05	3.61	0.47								
0.06	4.98	0.57	1.29	0.32						
0.07	6.53	0.66	1.70	0.38						
0.08	8.26	0.76	2.15	0.43	0.56	0.24				
0.09	10.17	0.85	2.64	0.48	0.69	0.28				
0.1	12.24	0.95	3.18	0.54	0.83	0.31				
0.15	24.99	1.42	6.49	0.81	1.70	0.46	0.52	0.28		
0.2	41.46	1.89	10.76	1.07	2.82	0.61	0.86	0.37	0.30	0.24
0.25	61.40	2.37	15.94	1.34	4.18	0.76	1.27	0.46	0.45	0.30
0.3	84.63	2.84	21.97	1.61	5.76	0.92	1.75	0.56	0.62	0.36
0.35	111.01	3.31	28.81	1.88	7.56	1.07	2.30	0.65	0.81	0.42
0.4	140.42	3.78	36.45	2.15	9.56	1.22	2.90	0.74	1.03	0.48
0.45	172.76	4.26	44.84	2.42	11.76	1.38	3.57	0.83	1.26	0.54
0.5	207.96	4.73	53.98	2.68	14.16	1.53	4.30	0.93	1.52	0.60
0.6	286.64	5.68	74.40	3.22	19.51	1.84	5.93	1.11	2.10	0.72
0.7		6.62	97.59	3.76	25.59	2.14	7.78	1.30	2.75	0.84
0.8			123.44	4.29	32.38	2.45	9.84	1.48	3.48	0.96
0.9			151.87	4.83	39.83	2.75	12.11	1.67	4.28	1.08
1			182.82	5.37	47.95	3.06	14.57	1.85	5.15	1.20
1.1			216.21	5.91	56.71	3.37	17.23	2.04	6.09	1.32
1.2			251.99	6.44	66.09	3.67	20.08	2.23	7.10	1.44
1.3			290.11	6.98	76.09	3.98	23.12	2.41	8.17	1.56
1.4					86.69	4.28	26.34	2.60	9.31	1.68
1.5					97.88	4.59	29.75	2.78	10.51	1.80
1.6					109.65	4.90	33.32	2.97	11.77	1.92
1.7					122.00	5.20	37.08	3.15	13.10	2.04
1.8					134.91	5.51	41.00	3.34	14.49	2.16
1.9					148.38	5.81	45.09	3.52	15.93	2.28
2					162.40	6.12	49.35	3.71	17.44	2.40
2.2					192.06	6.73	58.37	4.08	20.62	2.64
2.4							68.03	4.45	24.04	2.88
2.6							78.32	4.82	27.67	3.11
2.8							89.23	5.19	31.53	3.35
3							100.75	5.56	35.60	3.59
3.2							112.87	5.94	39.88	3.83
3.4							125.58	6.31	44.37	4.07
3.6							138.87	6.68	49.07	4.31
3.8							152.73	7.05	53.97	4.55
4							168.80	7.42	59.06	4.79
4.2							184.30	7.79	64.36	5.03
4.4							200.39	8.16	69.85	5.27
4.6									75.54	5.51
4.8									82.09	5.75
5									88.35	5.99
5.5									104.89	6.59

De → External pipe diameter (mm)
e → Pipe thickness (mm)
Di → Internal pipe diameter (mm)
V → Internal volume per metre of pipe (l/m)

Q → Flow (l/s)
 ΔP → Head loss per metre (mbar/m)
 v → Water circulation velocity (m/s)

Head loss in PB pipes according to international standard ISO/TR 10501

Units: ΔP : mbar/m v : m/s

De (mm)	50		63		75		90		110		125		160	
e (mm)	4.6		5.8		6.8		8.2		10		11.4		14.6	
Di (mm)	40.8		51.4		61.4		73.6		90		102.2		130.8	
V (l/m)	1.31		2.07		2.96		4.25		6.36		8.20		13.44	
Q (l/s)	ΔP	v	ΔP	v	ΔP	v	ΔP	v	ΔP	v	ΔP	v	ΔP	v
0.2														
0.3	0.21	0.23												
0.4	0.35	0.31	0.12	0.19										
0.5	0.52	0.38	0.17	0.24										
0.6	0.72	0.46	0.24	0.29	0.10	0.20								
0.7	0.94	0.54	0.31	0.34	0.13	0.24								
0.8	1.19	0.61	0.40	0.39	0.17	0.27	0.07	0.19						
0.9	1.47	0.69	0.49	0.43	0.21	0.30	0.09	0.21						
1	1.77	0.76	0.59	0.48	0.25	0.34	0.11	0.24						
1.5	3.61	1.15	1.20	0.72	0.52	0.51	0.22	0.35	0.08	0.24				
2	5.99	1.53	2.00	0.96	0.86	0.68	0.36	0.47	0.14	0.31				
2.5	8.88	1.91	2.96	1.20	1.27	0.84	0.54	0.59	0.21	0.39	0.11	0.30	0.03	0.19
3	12.24	2.29	4.08	1.45	1.75	1.01	0.74	0.71	0.28	0.47	0.15	0.37	0.05	0.22
3.5	16.05	2.68	5.35	1.69	2.29	1.18	0.97	0.82	0.37	0.55	0.20	0.43	0.06	0.26
4	20.30	3.06	6.76	1.93	2.90	1.35	1.22	0.94	0.47	0.63	0.26	0.49	0.08	0.30
4.5	24.98	3.44	8.32	2.17	3.57	1.52	1.51	1.06	0.58	0.71	0.32	0.55	0.10	0.33
5	30.06	3.82	10.01	2.41	4.30	1.69	1.81	1.18	0.70	0.79	0.38	0.61	0.12	0.37
6	41.78	4.59	13.80	2.89	5.92	2.03	2.50	1.41	0.96	0.94	0.52	0.73	0.16	0.45
7	55.15	5.35	18.11	3.37	7.77	2.36	3.28	1.65	1.26	1.10	0.69	0.85	0.21	0.52
8	70.13	6.12	23.14	3.86	9.83	2.70	4.15	1.88	1.59	1.26	0.87	0.98	0.27	0.60
9	86.69	6.88	28.61	4.34	12.19	3.04	5.10	2.12	1.96	1.41	1.07	1.10	0.33	0.67
10			34.59	4.82	14.73	3.38	6.14	2.35	2.36	1.57	1.29	1.22	0.40	0.74
11			41.06	5.30	17.49	3.72	7.33	2.59	2.79	1.73	1.52	1.34	0.47	0.82
12			48.02	5.78	20.46	4.05	8.57	2.82	3.25	1.89	1.77	1.46	0.55	0.89
13			55.46	6.27	23.63	4.39	9.90	3.06	3.74	2.04	2.04	1.58	0.63	0.97
14			63.38	6.75	27.00	4.73	11.31	3.29	4.31	2.20	2.33	1.71	0.72	1.04
15					30.57	5.07	12.81	3.53	4.88	2.36	2.65	1.83	0.81	1.12
16					34.33	5.40	14.39	3.76	5.48	2.52	2.98	1.95	0.91	1.19
18					42.44	6.08	17.78	4.23	6.77	2.83	3.68	2.19	1.12	1.34
20					51.31	6.75	21.50	4.70	8.18	3.14	4.45	2.44	1.36	1.49
22							25.52	5.17	9.72	3.46	5.28	2.68	1.61	1.64
24							29.85	5.64	11.36	3.77	6.17	2.93	1.89	1.79
26							34.47	6.11	13.13	4.09	7.13	3.17	2.18	1.93
28							39.39	6.58	15.00	4.40	8.15	3.41	2.49	2.08
30									16.98	4.72	9.23	3.66	2.82	2.23
35									22.41	5.50	12.18	4.27	3.72	2.60
40									28.50	6.29	15.48	4.88	4.74	2.98
45											19.14	5.49	5.86	3.35
50											23.14	6.10	7.08	3.72
55													8.40	4.09
60													9.83	4.47
65													11.35	4.84
70													12.97	5.21
75													14.69	5.58
80													16.50	5.95
85													18.40	6.33

De → External pipe diameter (mm)
e → Pipe thickness (mm)
Di → Internal pipe diameter (mm)
V → Internal volume per metre of pipe (l/m)

Q → Flow (l/s)
 ΔP → Head loss per metre (mbar/m)
v → Water circulation velocity (m/s)



Annex 6: Graph for the calculation of expansion in PB pipes

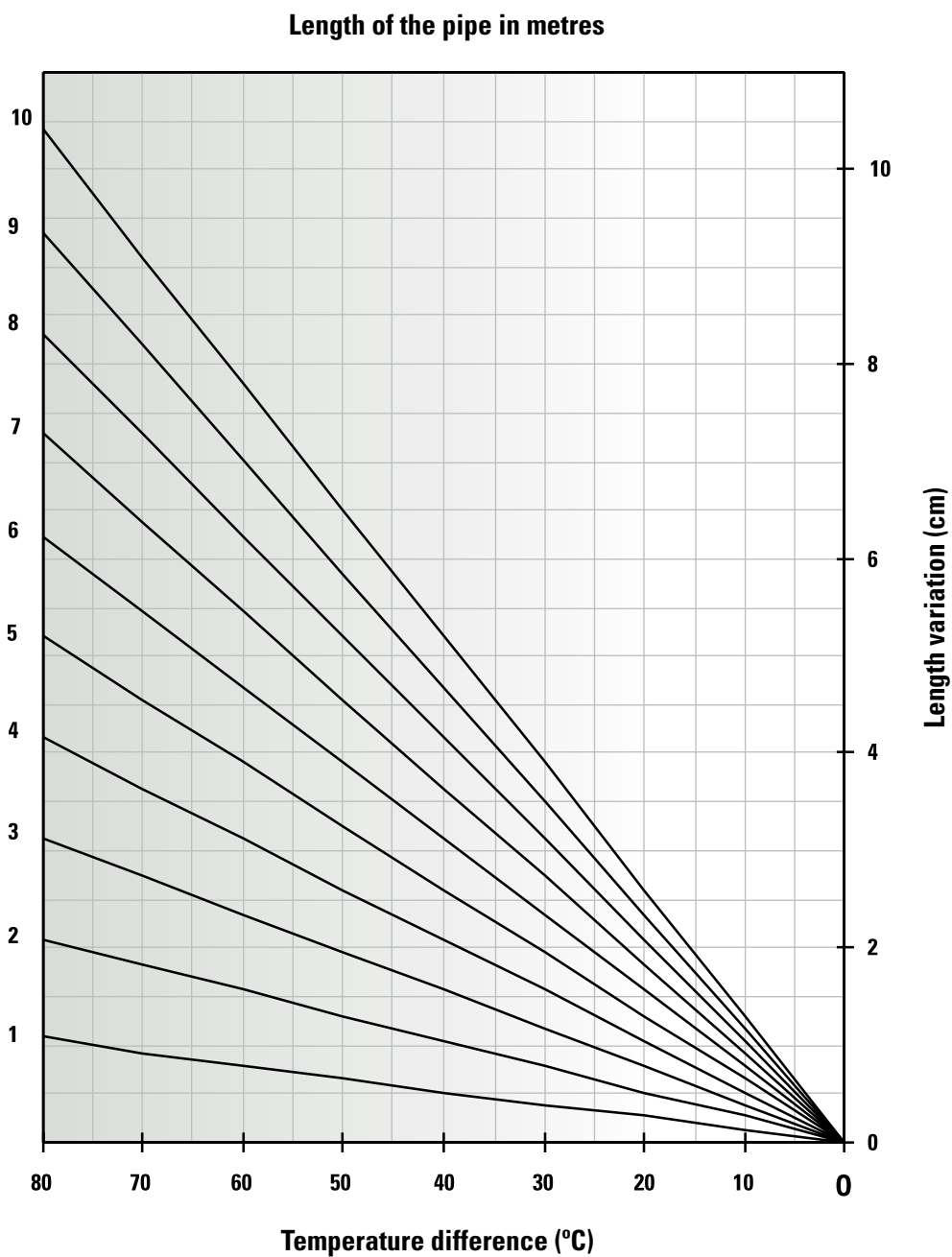

Annex 7: Graph for determining the expansion force in PB pipes

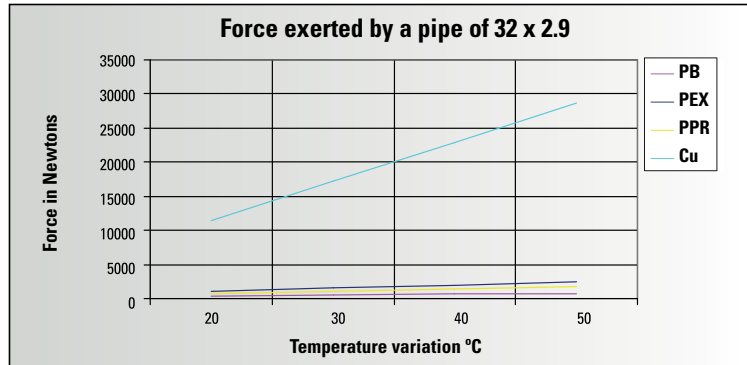

Graph comparing copper and plastic materials

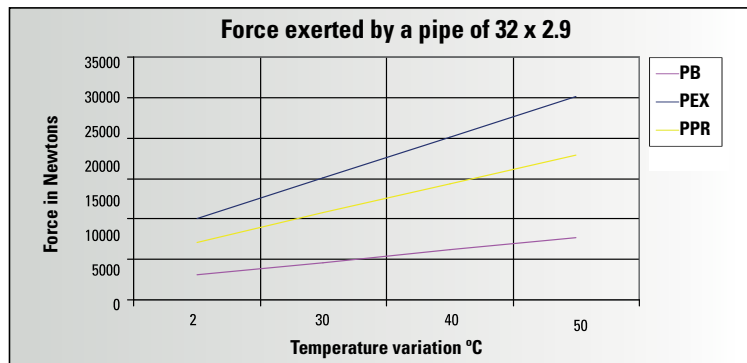

Graph comparing plastic materials

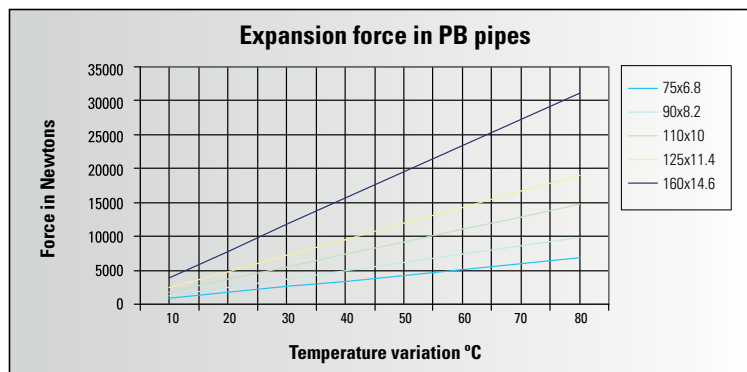
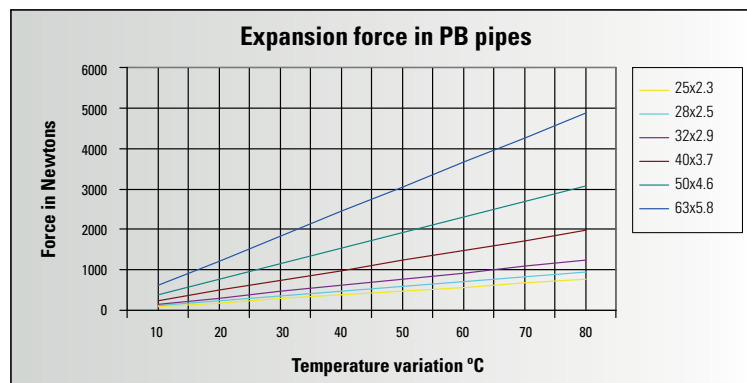



Annex 8: Table of PB resistance to chemical agents

A classification of the chemical resistance of PB taken from the standard ISO/TR 10358:1993 can be found below.

As indicated in the standard, the tests performed to characterise the chemical resistance have been carried out without pressure, so the classification is preliminary.

The results set out here are only valid for PB, components made of metal or other plastics are not taken into account. To determine the behaviour of these materials against chemical agents, consult the technical department of Nueva Terrain.

The concentrations of the chemical agents are described according to the legend:

- Dil. sol. = Dilute aqueous solution at a concentration equal to or less than 10%
- Sol. = Aqueous solution at a concentration higher than 10%, but not saturated
- Sat. sol. = Saturated aqueous solution, prepared at 20°C
- tg = At least technical-grade purity
- tg-s = Technical grade, solid
- tg-l = Technical grade, liquid
- tg-g = Technical grade, gas
- Work. sol. = Working solution of the concentration usually used in the industry concerned
- Susp. = Suspension of solid in a saturated solution at 20°C

The concentrations, unless indicated otherwise, are expressed as a percentage by mass at 20°C.

The code used to evaluate the chemical resistance is described below:

- + S: satisfactory resistance
- + L: limited resistance
- + NS: resistance not satisfactory

Annex 8: Table of PB resistance to chemical agents

Table of PB resistance to chemical agents*							
CHEMICAL ELEMENT	CONCENTRATION %	TEMPERATURE		CHEMICAL ELEMENT	CONCENTRATION %	TEMPERATURE	
		T 20° C	T 60° C			T 20° C	T 60° C
ACETALDEHYDE	tg-l	L	NS	BARIUM CARBONATE	Susp.	S	S
ACETIC ACID	up to 10	S	S	BARIUM CHLORIDE	Sat. Sol.	S	S
	10 to 40	S		BARIUM HYDROXIDE	Sat. Sol.	S	S
	50	S		BARIUM SULPHATE	Susp.	S	S
	40 to 60	S	L	BARIUM SULPHIDE	Sat. Sol.	S	S
	60	S		BEER	Work. Sol.	S	S
	80	S	S	BENZALDEHYDE	tg-l	L	NS
ACETIC ACID, GLACIAL	>96	L	NS	BENZENE	tg-l	NS	NS
ACETIC ANHYDRIDE	tg-l	S	S	BENZOIC ACID	Sat. Sol.	S	S
ACETONE	tg-l	S	S	BISMUTH CARBONATE	Sat. Sol.	S	S
ACETYLENE, GAS	tg-g	L	NS	BORAX	Sol.	S	S
ADIPIC ACID	Sat. Sol. (1,4%)	S	L		Sat. Sol.	S	S
AIR	tg-g	S	S	BORIC ACID	Dil. Sol.	S	S
ALLYL ALCOHOL	tg-l	S	S		Sat. Sol.	S	S
ALLYL CHLORIDE	Sat. Sol.	S	S	BORON TRIFLUORIDE	Sat. Sol.	S	S
ALUM (SEE 21)				BROMIC ACID	Sat. Sol.	S	S
ALUMINUM CHLORIDE	Sat. Sol.	S	S	BROMINE, LIQUID	tg-l	NS	NS
ALUMINUM FLUORIDE	Susp.	S	S	BROMINE WATER	Sat. Sol.	L	NS
ALUMINUM HYDROXIDE	Susp.	S	S	BUTANE, GAS	tg-g	NS	NS
ALUMINUM NITRATE	Sat. Sol.	S	S	N-BUTANOL	tg-l	S	S
ALUMINUM OXYCHLORIDE	Susp.	S	S	BUTYL ACETATE	tg-l	L	NS
ALUMINUM POTASSIUM SULPHATE	Sat. Sol.	S	S	BUTYRIC ACID	20	S	L
ALUMINUM SULPHATE	Sat. Sol.	L	NS	CALCIUM BISULPHITE	Sat. Sol.	S	S
AMMONIA, AQUEOUS	Sat. Sol.	S	S	CALCIUM CARBONATE	Susp.	S	S
AMMONIA, DRY GAS	tg-g	S	S	CALCIUM CHLORATE	Sat. Sol.	S	S
AMMONIA, LIQUID	tg-g	S	L	CALCIUM CHLORIDE	Sat. Sol.	S	S
AMMONIUM BIFLUORIDE	Sat. Sol.	S	S	CALCIUM HYDROXIDE	Sat. Sol.	S	S
AMMONIUM CARBONATE	Sat. Sol.	S	S	CALCIUM HYPOCHLORITE	Sol.	S	S
AMMONIUM CHLORIDE	Sat. Sol.	S	S	CALCIUM NITRATE	Sol.	S	S
AMMONIUM FLUORIDE	up to 20	S		CALCIUM SULPHATE	Susp.	S	S
	25	S	L	CALCIUM HYDROGEN SULPHIDE	Sol.	S	S
AMMONIUM METAPHOSPHATE	Sat. Sol.	S	S	CARBON DIOXIDE, AQUEOUS SOL.	Sat. Sol.	S	S
AMMONIUM NITRATE	Sat. Sol.	S	S	CARBON DIOXIDE, DRY GAS	tg-g	S	S
AMMONIUM PERSULPHATE	Sat. Sol.	S	S	CARBON DIOXIDE, WET GAS	tg-g	S	S
AMMONIUM PHOSPHATE	Sat. Sol.	S	S	CARBON DISULPHIDE	tg-l	NS	NS
AMMONIUM SULPHATE	Sat. Sol.	S	S	CARBON MONOXIDE, GAS	tg-g	S	S
AMMONIUM SULPHIDE	Sat. Sol.	S	S	CARBON TETRACHLORIDE	tg-l	NS	NS
AMMONIUM THIOCYANATE	Sat. Sol.	S	S	CASTOR OIL	tg-l	S	S
AMYL ALCOHOL	tg-l	S	S	CHLORINE, AQUEOUS (SEE 102)			
ANILINE	tg-l	L	L	CHLORINE, DRY GAS	tg-g	NS	NS
ANILINE HYDROCHLORIDE	Sat. Sol.	NS	NS	CHLORINE WATER	Sat. Sol.	S	S
ANTIMONY (III) CHLORIDE	Sat. Sol.	S	S	CHLORINE, WET GAS	tg-g	NS	NS
APPLE JUICE	Work. Sol.	S		CHLOROACETIC ACID (SEE ALSO 257)	Sat. Sol.	NS	NS
AQUA REGIA	HCl/HNO3 (3/1)	NS	NS	CHLOROBENZENE	tg-l	NS	NS
ARSENIC ACID	Sat. Sol.	S	S	CHLOROFORM	tg-l	L	NS
BARIUM BROMIDE	Sat. Sol.	S	S	CHLOROSULPHONIC ACID	tg-s		NS
CHROME ALUM (CHROMIUM POTASSIUM SULPHATE)	Sol.	S	S	FLUOSILICIC ACID	Sat. Sol.	S	S

RESISTANCE KEY

- + S: satisfactory resistance
- + L: limited resistance
- + NS: resistance not satisfactory

Note: Panel valid exclusively for Polybutylene. For other plastic or metal materials included in the system or joint, consult the technical department.



Annex 8: Table of PB resistance to chemical agents

Table of PB resistance to chemical agents*							
CHEMICAL ELEMENT	CONCENTRATION %	TEMPERATURE		CHEMICAL ELEMENT	CONCENTRATION %	TEMPERATURE	
		T 20° C	T 60° C			T 20° C	T 60° C
CHROMIC ACID	10	S	S	FORMALDEHYDE	Dil. Sol.	S	S
	20	S	S		30 to 40	S	S
	25	S	S		50	S	S
	30	S	S	FORMIC ACID	10	S	S
	40	S			85 to tg-l	S	S
	50	S		FREON - F12	Work. Sol.	S	S
CITRIC ACID	Sat. Sol.	S	S	GAS, MANUFACTURED	tg-g	S	L
COCONUT OIL	Work. Sol.	S	S	GAS, NATURAL, DRY	tg-g	S	L
COPPER (II) CHLORIDE	Sat. Sol.	S	S	GAS, NATURAL, WET	tg-g	S	L
COPPER (II) CYANIDE	Sat. Sol.	S	S	GASOLINE (FUEL)	Work. Sol.	NS	NS
COPPER (II) FLUORIDE	2	S	S	GELATINE	Sol.	S	S
COPPER (II) NITRATE	Sat. Sol.	S	S	GLUCOSE	Sol.	S	S
COPPER (II) SULPHATE	Sat. Sol.	S	S	GLYCERINE	tg-l	S	S
COTTONSEED OIL	Work. Sol.	S	S	GLYCOLIC ACID	30	S	S
CRESOLS	tg-l	NS	NS	HEPTANE	tg-l	NS	NS
CRESYLIC ACID	50	NS	NS	HEXANE	tg-l	NS	NS
CYCLOHEXANOL	tg-s	S	L	1-HEXANOL	tg-l	S	S
CYCLOHEXANONE	tg-l	NS	NS	HONEY	Work. Sol.	S	S
DEXTRIN	Sol.	S	S	HORSERADISH	Work. Sol.	S	S
DEXTROSE	Sol.	S	S	HYDROBROMIC ACID	up to 20	S	S
DIAZO SALTS	Work. Sol.	S	S	HYDROCHLORIC ACID	up to 10	S	S
DICHLOROMETHANE (SEE 253)					20	S	S
DIESEL FUEL	Work. Sol.	L	NS		10 to 20	S	S
DIETHANOLAMINE	tg-s	S			up to 25	S	S
DIETHYLAMINE	tg-l				30	S	
DIETHYL ETHER (SEE 160)					>30	S	
DIGLYCOLIC ACID	tg-s	S	S		36	S	
DIMETHYLAMINE, GAS	tg-g	NS	NS		Conc.	S	S
DIOCTYL PHTALATE	tg-l	L	NS	HYDROCYANIC ACID	tg-l	S	S
DISODIUM PHOSPHATE (371)				HYDROFLUORIC ACID	up to 10	S	S
ETHANOL	tg-l	S	S		48	S	S
ETHYL ACETATE	tg-l	L	NS		60	S	S
ETHYLENE BROMIDE	tg-l	NS	NS	HYDROGEN	tg-g	S	S
ETHYLENE CHLOROHYDRIN	tg-l	NS	NS	HYDROGEN PEROXIDE	up to 10	S	S
1,2 ETHYLENE DICHLORIDE	tg-l	S	S		30	S	S
ETHYLENE GLYCOL	tg-l	S	S		50	NS	NS
ETHYL ETHER	tg-l	L	NS		90	NS	NS
FERRIC CHLORIDE	Sat. Sol.	S	S	HYDROGEN PHOSPHIDE (SEE 287)			
FERRIC NITRATE	Sat. Sol.	S	S	HYDROGEN SULPHIDE, AQUEOUS	Sat. Sol.	S	S
FERRIC SULPHATE	Sat. Sol.	S	S	HYDROGEN SULPHIDE, DRY GAS	tg-g	S	S
FEROUS CHLORIDE	Sat. Sol.	S	S	HYDROQUINONE	Sat. Sol.	S	S
FEROUS SULPHATE	Sat. Sol.	S	S	HYPOCHLOROUS ACID	Sat. Sol.	S	S
FLUOBORIC ACID	tg-s	S	S	ISOPROPYL ALCOHOL	tg-l	S	S
FLUORINE GAS, DRY	tg-g	L	NS	LACTIC ACID	10	S	S
FLUORINE GAS, WET	tg-g	L	NS		28	S	S
LAURYL CHLORIDE	Sat. Sol.	S	L	PHOSPHINE	tg-g	S	
LEAD ACETATE	Dil. Sol.	S	S	PHOSPHORIC ACID	up to 50	S	S
	Sat. Sol.	S	S		50 to 75	S	L

RESISTANCE KEY

- + S: satisfactory resistance
- + L: limited resistance
- + NS: resistance not satisfactory

Note: Panel valid exclusively for Polybutylene. For other plastic or metal materials included in the system or joint, consult the technical department.

Annex 8: Table of PB resistance to chemical agents

Table of PB resistance to chemical agents*							
CHEMICAL ELEMENT	CONCENTRATION %	TEMPERATURE		CHEMICAL ELEMENT	CONCENTRATION %	TEMPERATURE	
		T 20° C	T 60° C			T 20° C	T 60° C
LINSEED OIL	Work. Sol.	S	S	PICRIC ACID (SUBL.)	Sat. Sol.	S	L
LUBRICATING OILS	tg-l	S	S	POTASSIUM ALUMINIUM SULPHATE (SEE 21)			
MAGNESIUM CARBONATE	Susp.	S	S	POTASSIUM BICARBONATE	Sat. Sol.	S	S
MAGNESIUM CHLORIDE	Sat. Sol.	S	S	POTASSIUM BICHROMATE (SEE 307)			
MAGNESIUM HYDROXIDE	Sat. Sol.	S	S	POTASSIUM BISULPHATE	Sat. Sol.	S	S
MAGNESIUM NITRATE	Sat. Sol.	S	S	POTASSIUM BORATE	Sat. Sol.	S	S
MAGNESIUM SULPHATE	Sat. Sol.	S	S	POTASSIUM BROMATE	up to 10	S	S
MALEIC ACID (DEC.AT 160°C)	Sat. Sol.	S	S	POTASSIUM BROMIDE	Sat. Sol.	S	S
MALEIC ACID (SUBL.)	Sol.	S	S	POTASSIUM CARBONATE	Sat. Sol.	S	S
	Sat. Sol.	S	S	POTASSIUM CHLORATE	Sat. Sol.	S	S
MERCURIC CHLORIDE	Sat. Sol.	S	S	POTASSIUM CHLORIDE	Sat. Sol.	S	S
MERCURIC CYANIDE	Sat. Sol.	S	S	POTASSIUM CHLORITE	Sat. Sol.	S	S
MERCUROUS NITRATE	Sol.	S	S	POTASSIUM CHROMATE	Sat. Sol.	S	S
	Sat. Sol.	S	S		40	S	S
MERCURY	tg-l	S	S	POTASSIUM CUPROCYANIDE	Sat. Sol.	S	S
MERCURY (II) CHLORIDE (SEE 237)				POTASSIUM CYANIDE	Sol.	S	S
MERCURY (II) CYANIDE (SEE 238)					Sat. Sol.	S	S
METHYL ALCOHOL	tg-l	S	S	POTASSIUM DICHROMATE	Sat. Sol.	S	S
METHYL ETHYL KETONE	tg-l	S	L		40	S	S
METHYL SULPHONIC ACID	tg-l	S	S	POTASSIUM FERRICYANIDE	Sat. Sol.	S	S
METHYLENE CHLORIDE	tg-l	S	L	POTASSIUM FLUORIDE	Sat. Sol.	S	S
MILK	Work. Sol.	S	S	POTASSIUM HEXACYANOFERRATE (III) (POTASSIUM FERROCYANIDE)	Sat. Sol.	S	S
NICKEL ACETATE	Sat. Sol.	S	S	POTASSIUM HEXACYANOFERRATE (III) (SEE 308)	Sat. Sol.		
NICKEL CHLORIDE	Sat. Sol.	S	S	POTASSIUM HYDROGEN CARBONATE (SEE 294)			
NICKEL NITRATE	Sat. Sol.	S	S	POTASSIUM HYDROGEN SULPHATE (SEE 296)			
NICKEL SULPHATE	Sat. Sol.	S	S	POTASSIUM HYDROXIDE	10	S	S
NICOTINIC ACID	Susp.	S	S		20	S	S
NITRIC ACID	10	L	NS	POTASSIUM NITRATE	Sat. Sol.	S	S
	20	NS	NS	POTASSIUM PERBORATE	Sat. Sol.	S	S
	25	NS	NS	POTASSIUM PERMANGANATE	10	S	S
	30	NS	NS	POTASSIUM PERSULPHATE	Sat. Sol.	S	S
	35	NS	NS	POTASSIUM SULPHATE	Sat. Sol.	S	S
	40	NS	NS	POTASSIUM SULPHIDE	Sat. Sol.	S	S
	up to 45	NS	NS	POTASSIUM SULPHITE	Sat. Sol.	S	S
	50	NS	NS	POTASSIUM THIOSULPHATE	Sat. Sol.	S	S
	>50	NS	NS	PROPANE, GAS	tg-g	S	
NITRIC ACID, FUMING (WITH NITROGEN DIOXIDE)		NS	NS	PROPYL ALCOHOL	tg-l	S	S
OILS AND FATS	tg-l	S	S	SALICYLIC ACID	Sat. Sol.	S	
OLEUM		NS	NS	SELENIC ACID	Sat. Sol.	S	S
ORTHOPHOSPHORIC ACID (SEE 288)				SILICIC ACID	Susp.	S	S
PERCHLORIC ACID	10	L	NS	SILVER ACETATE	Sat. Sol.	S	S
	70	NS	NS	SILVER CYANIDE	Sat. Sol.	S	S
PHENOL	tg-s	S	L	SILVER NITRATE	Sat. Sol.	L	NS
LAURYL CHLORIDE	Sat. Sol.	S	L	PHOSPHINE	tg-g	S	
LEAD ACETATE	Dil. Sol.	S	S	PHOSPHORIC ACID	up to 50	S	S
	Sat. Sol.	S	S		50 to 75	S	L
LINSEED OIL	Work. Sol.	S	S	PICRIC ACID (SUBL.)	Sat. Sol.	S	L
LUBRICATING OILS	tg-l	S	S	POTASSIUM ALUMINIUM SULPHATE (SEE 21)			

RESISTANCE KEY

- + S: satisfactory resistance
- + L: limited resistance
- + NS: resistance not satisfactory

Note: Panel valid exclusively for Polybutylene. For other plastic or metal materials included in the system or joint, consult the technical department.



Annex 8: Table of PB resistance to chemical agents

Table of PB resistance to chemical agents*							
CHEMICAL ELEMENT	CONCENTRATION %	TEMPERATURE		CHEMICAL ELEMENT	CONCENTRATION %	TEMPERATURE	
		T 20° C	T 60° C			T 20° C	T 60° C
MAGNESIUM CARBONATE	Susp.	S	S	POTASSIUM BICARBONATE	Sat. Sol.	S	S
MAGNESIUM CHLORIDE	Sat. Sol.	S	S	POTASSIUM BICHROMATE (SEE 307)			
MAGNESIUM HYDROXIDE	Sat. Sol.	S	S	POTASSIUM BISULPHATE	Sat. Sol.	S	S
MAGNESIUM NITRATE	Sat. Sol.	S	S	POTASSIUM BORATE	Sat. Sol.	S	S
MAGNESIUM SULPHATE	Sat. Sol.	S	S	POTASSIUM BROMATE	up to 10	S	S
MALEIC ACID (DEC.AT 160°C)	Sat. Sol.	S	S	POTASSIUM BROMIDE	Sat. Sol.	S	S
MALEIC ACID (SUBL.)	Sol.	S	S	POTASSIUM CARBONATE	Sat. Sol.	S	S
MERCURIC CHLORIDE	Sat. Sol.	S	S	POTASSIUM CHLORATE	Sat. Sol.	S	S
MERCURIC CYANIDE	Sat. Sol.	S	S	POTASSIUM CHLORIDE	Sat. Sol.	S	S
MERCUROUS NITRATE	Sol.	S	S	POTASSIUM CHLORITE	Sat. Sol.	S	S
	Sat. Sol.	S	S	POTASSIUM CHROMATE	Sat. Sol.	S	S
MERCURY	tg-l	S	S		40	S	S
MERCURY (II) CHLORIDE (SEE 237)				POTASSIUM CUPROCYANIDE	Sat. Sol.	S	S
MERCURY (II) CYANIDE (SEE 238)				POTASSIUM CYANIDE	Sol.	S	S
METHYL ALCOHOL	tg-l	S	S		Sat. Sol.	S	S
METHYL ETHYL KETONE	tg-l	S	L	POTASSIUM DICHROMATE	Sat. Sol.	S	S
METHYL SULPHONIC ACID	tg-l	S	S		40	S	S
METHYLENE CHLORIDE	tg-l	S	L	POTASSIUM FERRICYANIDE	Sat. Sol.	S	S
MILK	Work. Sol.	S	S	POTASSIUM FLUORIDE	Sat. Sol.	S	S
NICKEL ACETATE	Sat. Sol.	S	S	POTASSIUM HEXACYANOFERRATE (II) (POTASSIUM FERROCYANIDE)	Sat. Sol.	S	S
NICKEL CHLORIDE	Sat. Sol.	S	S	POTASSIUM HEXACYANOFERRATE (III) (SEE 308)	Sat. Sol.		
NICKEL NITRATE	Sat. Sol.	S	S	POTASSIUM HYDROGEN CARBONATE (SEE 294)			
NICKEL SULPHATE	Sat. Sol.	S	S	POTASSIUM HYDROGEN SULPHATE (SEE 296)			
NICOTINIC ACID	Susp.	S	S	POTASSIUM HYDROXIDE	10	S	S
NITRIC ACID	10	L	NS		20	S	S
	20	NS	NS	POTASSIUM NITRATE	Sat. Sol.	S	S
	25	NS	NS	POTASSIUM PERBORATE	Sat. Sol.	S	S
	30	NS	NS	POTASSIUM PERMANGANATE	10	S	S
	35	NS	NS	POTASSIUM PERSULPHATE	Sat. Sol.	S	S
	40	NS	NS	POTASSIUM SULPHATE	Sat. Sol.	S	S
	up to 45	NS	NS	POTASSIUM SULPHIDE	Sat. Sol.	S	S
	50	NS	NS	POTASSIUM SULPHITE	Sat. Sol.	S	S
	>50	NS	NS	POTASSIUM THIOSULPHATE	Sat. Sol.	S	S
NITRIC ACID, FUMING (WITH NITROGEN DIOXIDE)		NS	NS	PROPANE, GAS	tg-g	S	
OILS AND FATS	tg-l	S	S	PROPYL ALCOHOL	tg-l	S	S
OLEUM		NS	NS	SALICYLIC ACID	Sat. Sol.	S	
ORTHOPHOSPHORIC ACID (SEE 288)				SELENIC ACID	Sat. Sol.	S	S
PERCHLORIC ACID	10	L	NS	SILICIC ACID	Susp.	S	S
	70	NS	NS	SILVER ACETATE	Sat. Sol.	S	S
PHENOL	tg-s	S	L	SILVER CYANIDE	Sat. Sol.	S	S
SODIUM ACETATE	Sat. Sol.	S	S	SILVER NITRATE	Sat. Sol.	L	NS
SODIUM ACID SULPHATE (SEE 346)				SODIUM THIOSULPHATE (HYPOSULPHITE)	Sat. Sol.	S	S
SODIUM ANTIMONATE	Sat. Sol.	S	S	SUPHUR DIOXIDE, WET GAS		S	S
SODIUM ARSENITE	Sat. Sol.	S	S	SULPHUR TRIOXIDE	tg-l	L	NS
SODIUM BENZOATE	Sat. Sol.	S	S	SULPHURIC ACID	up to 10	S	S
SODIUM BICARBONATE	Sat. Sol.	S	S		15		
SODIUM BISULPHATE	Sat. Sol.	S	S		10 to 30	S	S
					10 to 50	S	S

RESISTANCE KEY

- + S: satisfactory resistance
- + L: limited resistance
- + NS: resistance not satisfactory

Note: Panel valid exclusively for Polybutylene. For other plastic or metal materials included in the system or joint, consult the technical department.

Annex 8: Table of PB resistance to chemical agents

Table of PB resistance to chemical agents*							
CHEMICAL ELEMENT	CONCENTRATION %	TEMPERATURE		CHEMICAL ELEMENT	CONCENTRATION %	TEMPERATURE	
		T 20° C	T 60° C			T 20° C	T 60° C
SODIUM BROMIDE	Sat. Sol.	S	S		50	S	S
SODIUM CARBONATE	Sat. Sol.	S	S		50 to 75	L	NS
	25	S	S		75 to 90	L	NS
	up to 50	S	S		95	NS	NS
SODIUM CHLORATE	Sat. Sol.	S	S		96	NS	NS
SODIUM CHLORIDE	Sat. Sol.	S	S		98	NS	NS
	10	S	S		Fuming	NS	NS
SODIUM CHLORITE	2	S		SULPHUROUS ACID	up to 30	S	S
SODIUM CHROMATE	Dil. Sol.	S	S	TANNIC ACID	Sol.	S	S
SODIUM CYANIDE	Sat. Sol.	S	S		Sat. Sol.	S	S
SODIUM DICHROMATE	Sat. Sol.	S	S	TARTARIC ACID	Sol.	S	S
SODIUM FERRICYANIDE	Sat. Sol.	S	S		Sat. Sol.	S	S
SODIUM FERROCYANIDE	Sat. Sol.	S	S	TETRAHYDROFURAN	tg-l	L	NS
SODIUM FLUORIDE	Sat. Sol.	S	S	THIONYL CHLORIDE	tg-l	S	S
SODIUM HEXACYANOFERRATE (II) (SEE 356)				TIN (II) CHLORIDE	Sat. Sol.	S	S
SODIUM HEXACYANOFERRATE (III) (SEE 355)				TIN (IV) CHLORIDE	Sol.	S	S
SODIUM HYDROGEN CARBONATE (SEE 345)				TOLUENE	tg-l	NS	NS
SODIUM HYDROGEN SULPHATE (SEE 346)				TRICHLOROETHYLENE	tg-l	NS	NS
SODIUM HYDROXIDE	Sol.	S	S	TRIETHANOLAMINE	tg-l	S	S
	Sat. Sol.	S	S	TRIMETHYLOLPROPANE	up to 10		
	1	S	S	TRISODIUM PHOSPHATE (SEE 372)			
	10 to 35	S	S	TURPENTINE	tg-l	NS	NS
SODIUM HYPCHLORITE	10 to 15	S	S	UREA	Sol.		
	20	S	L		Sat. Sol.	S	S
	12,5% Cl	S	S		10		
SODIUM NITRATE	Sat. Sol.	S	S	URINE		S	S
SODIUM NITRITE	Sat. Sol.	S	S	VINEGAR	Work. Sol.	S	S
SODIUM ORTHOPHOSPHATE (SEE 372)				WATER		S	S
SODIUM PERBORATE	Sat. Sol.			WATER, BRACKISH		S	S
SODIUM PHOSPHATE (SEE 371 & 372)	50			WATER, DISTILLED		S	S
SODIUM PHOSPHATE, ACID	Sat. Sol.	S	S	WATER, FRESH		S	S
SODIUM PHOSPHATE, NEUTRAL	Sat. Sol.			WATER, MINERAL	Work. Sol.	S	S
SODIUM SILICATE	Sol.	S	S	WATER, POTABLE	Work. Sol.	S	S
	Sat. Sol.	S	S	WATER, SEA		S	S
SODIUM SULPHATE	Sat. Sol.	S	S	WHISKEY	Work. Sol.	S	S
	0,1	S	S	WINE	Work. Sol.	S	S
SODIUM SULPHIDE	Sat. Sol.	S	S	WINES AND SPIRITS	Work. Sol.	S	S
SODIUM SULPHITE	Sat. Sol.	S	S	XYLENES	tg-l	NS	NS
	40	S	S	ZINC CARBONATE	Susp.	S	S
ZINC CHLORIDE	Sat. Sol.	S	S	ZINC NITRATE	Sat. Sol.	S	S
	58	S	S	ZINC OXIDE	Susp.	S	S
ZINC CHROMATE	Sat. Sol.	S	S	ZINC SULPHATE	Sat. Sol.	S	S
ZINC CYANIDE	Sat. Sol.	S	S				

RESISTANCE KEY

- + S: satisfactory resistance
- + L: limited resistance
- + NS: resistance not satisfactory

Note: Panel valid exclusively for Polybutylene. For other plastic or metal materials included in the system or joint, consult the technical department.



Annex 9: Sum-Up of TENDER specification according TERRAIN SDP

1.1 The piping system must be made in Polybutilene (also called PB-1, polybutene) and must resist the service conditions CLASS 2 / 10 bar according the EN ISO 15876-1, table 1 (70°C/10 bar/50 years, DF 1.5)

1.2 The pressure rating for hot and cold water of the PB piping system, under continuous service conditions, must be in compliance with EN ISO 15876. which is as following: (for SDR11/series 5 pipes)

Cold water (20°C) → 21.9 bar during 50 years lifetime and design factor of 1.25

Hot water (70°C) → 10,0 bar during 50 years lifetime and a design factor of 1.5

PN rate (SDR 11) → 21.9 bar during 50 years at 20°C and a design factor of 1.25

1.3 Only fully trained installers should do the assembling of the PB pipe system and shall be trained and certified by our agent in the territory.

1.4 Jointing technology (pipe joints)

The pipes and fittings must be entirely compatible with each other and from the same manufacturer. The jointing should be carried out in strict accordance with the manufacturer's instructions. In case that the contractor has to use pipe or fittings from another PB manufacturer, the consultant and NUEVA TERRAIN must be informed by written (letter) to give their approval.

1.5 The installation can be done with the following assembly technologies:

SDP PushFit type, available in the range from d16 up to d50mm

SDP Socket fusion type, available in the range from d16 up to 63mm

SDP Butt welding type, available in the range from d63 up to d160mm

Electrofusion type, available in the range from d63 up to d160mm

1.6 Standards/Certificates/Insurance warranty

1.6.1 The PB piping system must comply with the requirements specified in the new International regulation for PB systems which is the EN ISO 15876 or according the DIN16969/16968 and BS7291 part 1 & 2.

1.6.2 Only system which can provide the SYSTEM-certificate according the EN ISO 15876-5: 2004 e.g. AENOR o KIWA can be considered in this project. Note; the system-approval certifies the "jointing" itself and not only the pipe or the fittings.

1.6.3 The PB piping system must comply with the following NORMATIVE REFERENCES which are incorporate in the EN ISO 15876: eg EN 12108, ISO 4065, ISO 3136, EN ISO 9080, ISO 1133.

1.6.4 Only systems which can be approve a 10 years warranty shall be considered.

1.7 Pipes

The pipes must be marked with the manufacturer's name, type of material, pipe size and standard with which it complies. See example below:

TERRAIN SDP PB 110x10.0 – DIMENSION A – CLASE 2* / P 10 BAR – OPACO UNE EN ISO 15876-2 AENOR – N – 001/XXX date, shift // 20°C 21.9 bar // <CERFIF> MADE IN SPAIN (EU)

*) CLASE 2 (class 2) defines the temperature which is 70°C according with EN ISO 15876

The pipes can be delivered in coils or straight lengths, and the tubes shall be bundled by size in suitable bags clearly marked with the name of supplier.

Pipe characteristics for Push-Fit System Terrain SDP

Pipe characteristics for Push-Fit System Terrain SDP

Pipe class conforming ISO EN 15786-2											Class 2 (70°C, 10 bar, 50 years, SF 1.5)		
PN definition in bar		27,2 bar					21,9 bar						
Pipe series		4					5						
SDR		SDR 9					SDR 11						
Pipe OD outer Diameter	mm	15	16	20	22	25	28	32	40	50			
Wall Thickness	mm	1,7	1,8	2,3	2,0	2,3	2,5	2,9	3,7	4,6			
Pipe inner diameter	mm	11,6	12,4	15,4	18,0	20,4	23,0	26,2	32,6	40,8			
Length in straight Coil	m	3	3	3	3	3	3	5,8	5,8	5,8			
		5,8	5,8	5,8	5,8	5,8	5,8	5,8	5,8	5,8			
		50	50	50	50	50	50	50	50	50			
		100	100	50	50	50	50	50	50	50			

Pipe class conforming ISO EN 15786-2											Class 2 (70°C, 10 bar, 50 years, SF 1.5)		
PN definition in bar		34,5			27,2			21,9 bar					
Pipe series		3,2			4			5					
SDR		7,4			9			SDR 11					
DN (mm)		12	15	20	25	32	40	50	60	80	100	125	150
DN (inch)		½"	½"	¾"	1"	1 ¼"	1 ½"	2"	2 ½"	3"	4"	4 ½"	6"
Pipe OD outer Diameter	mm	16	20	25	32	40	50	63	75	90	110	125	160
Wall Thickness	mm	2,2	2,3	2,3	2,9	3,7	4,6	5,8	6,8	8,2	10,0	11,4	14,6
Pipe inner diameter	mm	11,6	15,4	20,4	26,2	32,6	40,8	51,4	61,4	73,6	90,0	102,2	130,8
Length in straight Coil	m	3	3	3	5,8	5,8	5,8	5,8	5,8	5,8	5,8	5,8	5,8
		5,8	5,8	5,8	5,8	5,8	5,8	5,8	5,8	5,8	5,8	5,8	5,8
		50	50	50	50	50	50	50	50	50	50	50	50
		100	100	50	50	50	50	50	50	50	50	50	50

Definition of PN: working pressure at 20°C for 50 years lifetime with safety factor of 1,25

Definition of SDR: Standard Dimension Ratio (SDR= OD/pipe wall thickness)



Annex 10: Hot water expulsion time

There is always a delay between the instant when you open the hot water tap and when the hot water is really expelled through it. A hot water installation must be calculated and designed to minimize this delay, it's a matter of energy and water saving and also a comfort issue.

Calculating how long will take the hot water to arrive to the tap, will allow to compare and adjust the piping system parameters and to optimize it.

The following tables are to calculate the expulsion time which the hot water needs form the heater (boiler) till the tap respectively from the risers (hot water supply & return)

EXAMPLE (given data):

2m - Length of the pipe (d22mm) from the boiler or riser till the manifold

5m - Length of the pipe (d15mm) from the manifold till the tap

0,1 l/s (6 l/min) - Flow Rate of the Tap from the Hand Washbasin

QUESTION: How much time will it take till the hot water arrives to the tap?

SOLUTION

Table d22x2,0mm: check figure in the "intercept point" with 2m and 0,1 l/s flow rate **5,1 sec**

Table d15x1,7mm: check figure in the "intercept point" with 5m and 0,1 l/s flow rate **5,3 sec**

Total time 10,4 sec

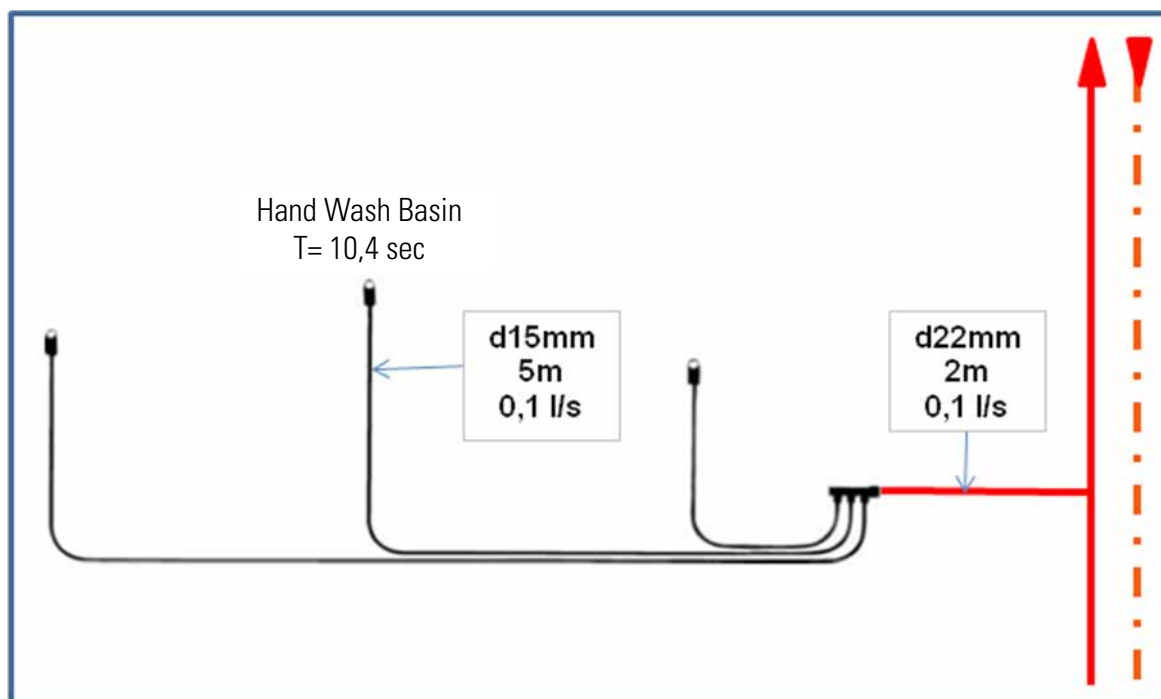

PB pipe d25 x 2.3 mm

Internal volume per meter: 0.33 litre

Pipe length (m)	Flow rate (l/s)										Wasting of water (litres)
	0,1	0,15	0,2	0,25	0,3	0,4	0,5	0,6	0,7	0,8	
1	3,3	2,2	1,6	1,3	1,1	0,8	0,7	0,5	0,5	0,4	0,3
2	6,5	4,4	3,3	2,6	2,2	1,6	1,3	1,1	0,9	0,8	0,7
3	9,8	6,5	4,9	3,9	3,3	2,5	2,0	1,6	1,4	1,2	1,0
4	13,1	8,7	6,5	5,2	4,4	3,3	2,6	2,2	1,9	1,6	1,3
5	16,3	10,9	8,2	6,5	5,4	4,1	3,3	2,7	2,3	2,0	1,6
6	19,6	13,1	9,8	7,8	6,5	4,9	3,9	3,3	2,8	2,5	2,0
7	22,9	15,3	11,4	9,2	7,6	5,7	4,6	3,8	3,3	2,9	2,3
8	26,1	17,4	13,1	10,5	8,7	6,5	5,2	4,4	3,7	3,3	2,6
9	29,4	19,6	14,7	11,8	9,8	7,4	5,9	4,9	4,2	3,7	2,9
10	32,7	21,8	16,3	13,1	10,9	8,2	6,5	5,4	4,7	4,1	3,3
11	36,0	24,0	18,0	14,4	12,0	9,0	7,2	6,0	5,1	4,5	3,6
12	39,2	26,1	19,6	15,7	13,1	9,8	7,8	6,5	5,6	4,9	3,9
13	42,5	28,3	21,2	17,0	14,2	10,6	8,5	7,1	6,1	5,3	4,2
14	45,8	30,5	22,9	18,3	15,3	11,4	9,2	7,6	6,5	5,7	4,6
15	49,0	32,7	24,5	19,6	16,3	12,3	9,8	8,2	7,0	6,1	4,9
16	52,3	34,9	26,1	20,9	17,4	13,1	10,5	8,7	7,5	6,5	5,2
17	55,6	37,0	27,8	22,2	18,5	13,9	11,1	9,3	7,9	6,9	5,6
18	58,8	39,2	29,4	23,5	19,6	14,7	11,8	9,8	8,4	7,4	5,9
19	62,1	41,4	31,0	24,8	20,7	15,5	12,4	10,3	8,9	7,8	6,2
20	65,4	43,6	32,7	26,1	21,8	16,3	13,1	10,9	9,3	8,2	6,5

Not recommended as the waiting time is longer than 12 sec.

PB pipe d15 x 1.7 mm

Internal volume per meter: 0,106 litre

Pipe length (m)	Flow rate (l/s)									Wasting of water (litres)
	0,03	0,065	0,1	0,15	0,2	0,25	0,3	0,4	0,5	
1	3,5	1,6	1,1	0,7	0,5	0,4	0,4	0,3	0,2	0,1
2	7,0	3,3	2,1	1,4	1,1	0,8	0,7	0,5	0,4	0,2
3	10,6	4,9	3,2	2,1	1,6	1,3	1,1	0,8	0,6	0,3
4	14,1	6,5	4,2	2,8	2,1	1,7	1,4	1,1	0,8	0,4
5	17,6	8,1	5,3	3,5	2,6	2,1	1,8	1,3	1,1	0,5
6	21,1	9,8	6,3	4,2	3,2	2,5	2,1	1,6	1,3	0,6
7	24,7	11,4	7,4	4,9	3,7	3,0	2,5	1,8	1,5	0,7
8	28,2	13,0	8,5	5,6	4,2	3,4	2,8	2,1	1,7	0,8
9	31,7	14,6	9,5	6,3	4,8	3,8	3,2	2,4	1,9	1,0
10	35,2	16,3	10,6	7,0	5,3	4,2	3,5	2,6	2,1	1,1
11	38,7	17,9	11,6	7,7	5,8	4,6	3,9	2,9	2,3	1,2
12	42,3	19,5	12,7	8,5	6,3	5,1	4,2	3,2	2,5	1,3
13	45,8	21,1	13,7	9,2	6,9	5,5	4,6	3,4	2,7	1,4
14	49,3	22,8	14,8	9,9	7,4	5,9	4,9	3,7	3,0	1,5
15	52,8	24,4	15,9	10,6	7,9	6,3	5,3	4,0	3,2	1,6
16	56,4	26,0	16,9	11,3	8,5	6,8	5,6	4,2	3,4	1,7
17	59,9	27,6	18,0	12,0	9,0	7,2	6,0	4,5	3,6	1,8
18	63,4	29,3	19,0	12,7	9,5	7,6	6,3	4,8	3,8	1,9
19	66,9	30,9	20,1	13,4	10,0	8,0	6,7	5,0	4,0	2,0
20	70,5	32,5	21,1	14,1	10,6	8,5	7,0	5,3	4,2	2,1

Not recommended as the waiting time is longer than 12 sec.

Not recommended as there is more than 1 bar of pressure drop.



PB pipe d22x 2,0 mm

Internal volume per meter: 0,254 litre

Pipe length (m)	Flow rate (l/s)										Wasting of water (litres)
	0,1	0,15	0,2	0,25	0,3	0,4	0,5	0,6	0,7	0,8	
	Expulsion time in seconds										
1	2,5	1,7	1,3	1,0	0,8	0,6	0,5	0,4	0,4	0,3	0,3
2	5,1	3,4	2,5	2,0	1,7	1,3	1,0	0,8	0,7	0,6	0,5
3	7,6	5,1	3,8	3,1	2,5	1,9	1,5	1,3	1,1	1,0	0,8
4	10,2	6,8	5,1	4,1	3,4	2,5	2,0	1,7	1,5	1,3	1,0
5	12,7	8,5	6,4	5,1	4,2	3,2	2,5	2,1	1,8	1,6	1,3
6	15,3	10,2	7,6	6,1	5,1	3,8	3,1	2,5	2,2	1,9	1,5
7	17,8	11,9	8,9	7,1	5,9	4,5	3,6	3,0	2,5	2,2	1,8
8	20,4	13,6	10,2	8,1	6,8	5,1	4,1	3,4	2,9	2,5	2,0
9	22,9	15,3	11,5	9,2	7,6	5,7	4,6	3,8	3,3	2,9	2,3
10	25,4	17,0	12,7	10,2	8,5	6,4	5,1	4,2	3,6	3,2	2,5
11	28,0	18,7	14,0	11,2	9,3	7,0	5,6	4,7	4,0	3,5	2,8
12	30,5	20,4	15,3	12,2	10,2	7,6	6,1	5,1	4,4	3,8	3,1
13	33,1	22,1	16,5	13,2	11,0	8,3	6,6	5,5	4,7	4,1	3,3
14	35,6	23,7	17,8	14,2	11,9	8,9	7,1	5,9	5,1	4,5	3,6
15	38,2	25,4	19,1	15,3	12,7	9,5	7,6	6,4	5,5	4,8	3,8
16	40,7	27,1	20,4	16,3	13,6	10,2	8,1	6,8	5,8	5,1	4,1
17	43,3	28,8	21,6	17,3	14,4	10,8	8,7	7,2	6,2	5,4	4,3
18	45,8	30,5	22,9	18,3	15,3	11,5	9,2	7,6	6,5	5,7	4,6
19	48,3	32,2	24,2	19,3	16,1	12,1	9,7	8,1	6,9	6,0	4,8
20	50,9	33,9	25,4	20,4	17,0	12,7	10,2	8,5	7,3	6,4	5,1

Not recommended as the waiting time is longer than 12 sec.

Not recommended as there is more than 1 bar of pressure drop.

PB pipe d16x 1,8 mm

Internal volume per meter: 0,121 litre

Pipe length (m)	Flow rate (l/s)									Wasting of water (litres)
	0,03	0,065	0,1	0,15	0,2	0,25	0,3	0,4	0,5	
	Expulsion time in seconds									
1	4,0	1,9	1,2	0,8	0,6	0,5	0,4	0,3	0,2	0,1
2	8,1	3,7	2,4	1,6	1,2	1,0	0,8	0,6	0,5	0,2
3	12,1	5,6	3,6	2,4	1,8	1,4	1,2	0,9	0,7	0,4
4	16,1	7,4	4,8	3,2	2,4	1,9	1,6	1,2	1,0	0,5
5	20,1	9,3	6,0	4,0	3,0	2,4	2,0	1,5	1,2	0,6
6	24,2	11,1	7,2	4,8	3,6	2,9	2,4	1,8	1,4	0,7
7	28,2	13,0	8,5	5,6	4,2	3,4	2,8	2,1	1,7	0,8
8	32,2	14,9	9,7	6,4	4,8	3,9	3,2	2,4	1,9	1,0
9	36,2	16,7	10,9	7,2	5,4	4,3	3,6	2,7	2,2	1,1
10	40,3	18,6	12,1	8,1	6,0	4,8	4,0	3,0	2,4	1,2
11	44,3	20,4	13,3	8,9	6,6	5,3	4,4	3,3	2,7	1,3
12	48,3	22,3	14,5	9,7	7,2	5,8	4,8	3,6	2,9	1,4
13	52,3	24,2	15,7	10,5	7,8	6,3	5,2	3,9	3,1	1,6
14	56,4	26,0	16,9	11,3	8,5	6,8	5,6	4,2	3,4	1,7
15	60,4	27,9	18,1	12,1	9,1	7,2	6,0	4,5	3,6	1,8
16	64,4	29,7	19,3	12,9	9,7	7,7	6,4	4,8	3,9	1,9
17	68,4	31,6	20,5	13,7	10,3	8,2	6,8	5,1	4,1	2,1
18	72,5	33,4	21,7	14,5	10,9	8,7	7,2	5,4	4,3	2,2
19	76,5	35,3	22,9	15,3	11,5	9,2	7,6	5,7	4,6	2,3
20	80,5	37,2	24,2	16,1	12,1	9,7	8,1	6,0	4,8	2,4

Not recommended as the waiting time is longer than 12 sec.

Not recommended as there is more than 1 bar of pressure drop.

PB pipe d20x 2,3 mm

Internal volume per meter: 0,186 litre

Pipe length (m)	Flow rate (l/s)										Wasting of water (litres)
	0,1	0,15	0,2	0,25	0,3	0,4	0,5	0,6	0,7	0,8	
1	1,9	1,2	0,9	0,7	0,6	0,5	0,4	0,3	0,3	0,2	0,2
2	3,7	2,5	1,9	1,5	1,2	0,9	0,7	0,6	0,5	0,5	0,4
3	5,6	3,7	2,8	2,2	1,9	1,4	1,1	0,9	0,8	0,7	0,6
4	7,5	5,0	3,7	3,0	2,5	1,9	1,5	1,2	1,1	0,9	0,7
5	9,3	6,2	4,7	3,7	3,1	2,3	1,9	1,6	1,3	1,2	0,9
6	11,2	7,5	5,6	4,5	3,7	2,8	2,2	1,9	1,6	1,4	1,1
7	13,0	8,7	6,5	5,2	4,3	3,3	2,6	2,2	1,9	1,6	1,3
8	14,9	9,9	7,5	6,0	5,0	3,7	3,0	2,5	2,1	1,9	1,5
9	16,8	11,2	8,4	6,7	5,6	4,2	3,4	2,8	2,4	2,1	1,7
10	18,6	12,4	9,3	7,5	6,2	4,7	3,7	3,1	2,7	2,3	1,9
11	20,5	13,7	10,2	8,2	6,8	5,1	4,1	3,4	2,9	2,6	2,0
12	22,4	14,9	11,2	8,9	7,5	5,6	4,5	3,7	3,2	2,8	2,2
13	24,2	16,1	12,1	9,7	8,1	6,1	4,8	4,0	3,5	3,0	2,4
14	26,1	17,4	13,0	10,4	8,7	6,5	5,2	4,3	3,7	3,3	2,6
15	27,9	18,6	14,0	11,2	9,3	7,0	5,6	4,7	4,0	3,5	2,8
16	29,8	19,9	14,9	11,9	9,9	7,5	6,0	5,0	4,3	3,7	3,0
17	31,7	21,1	15,8	12,7	10,6	7,9	6,3	5,3	4,5	4,0	3,2
18	33,5	22,4	16,8	13,4	11,2	8,4	6,7	5,6	4,8	4,2	3,4
19	35,4	23,6	17,7	14,2	11,8	8,8	7,1	5,9	5,1	4,4	3,5
20	37,3	24,8	18,6	14,9	12,4	9,3	7,5	6,2	5,3	4,7	3,7

Not recommended as the waiting time is longer than 12 sec.

Not recommended as there is more than 1 bar of pressure drop.



NUEVA TERRAIN S.L.

Pol. Ind. Jundiz
C/ Paduleta nº 2
01015 VITORIA - ÁLAVA (ESPAÑA)
Tel. 945 14 11 88 - Fax 945 14 33 36
E-mail: nuevaterrain@nuevaterrain.com
<http://www.nuevaterrain.com>